

Part D

Design Guidelines

9.0 Guidelines for Buildings and Surroundings

In its history and character, Thornhill is a distinct place in the larger municipality of the City of Vaughan. The City has recognized this special character by creating the Thornhill Vaughan Heritage Conservation District.

The purpose of these Design Guidelines is to help maintain the historic qualities that make up this sense of distinctness. They are intended to clarify and illustrate, in a useful way, the recognizable heritage characteristics found in the village. They will serve as a reference for anyone contemplating alterations or new development within the Heritage Conservation District.

The Guidelines examine the past in order to plan for the future. They recognize that change must and will come to Thornhill. The objective of the Guidelines is not to prevent change, but to ensure that change is complementary to the heritage character that already exists, and enhances, rather than harms it.

Guidelines:

- The intent of the Guidelines is to preserve and enhance the existing heritage character of Thornhill, which is widely appreciated by the citizens.
- It is recommended that design professionals with experience in heritage design and restoration be retained for work on significant heritage buildings in the District.



The south side of Centre Street, 1908. MM-Weaver #152. The nearest house no longer exists, but the next two, 19 and 33 Centre Street, are still in place.

9.0 Guidelines for Buildings and Surroundings

The character of Thornhill consists of many elements:

Significant natural features include the Thornhill Park, the Don River valley, the open spaces of the church yards, the Anglican Burying Ground, and the mature urban forest.

Significant cultural elements include the informal village plan, with its varied lot sizes and setbacks, rich planting, and almost 150 years of architectural history. The historic buildings serve to define the heritage character of the village.

These Design Guidelines are based on the concepts of preserving the existing heritage buildings, maintaining their character when they are renovated or added to, and ensuring that new development respects the qualities of place established by the existing heritage environment.

The Guidelines begin with a handbook of the architectural styles found in Thornhill. Over the years, many buildings have lost original detail such as trims, doors, and windows. The style book will be helpful to owners who want to restore original character, or who want to maintain what remains. It will assist in designing additions that respect the original style of the building. And it will provide a basis for **authentic** local historic references in the design of new buildings.

The stylebook is also a tool for looking at the existing heritage buildings, which offer the best guidelines of all: they are full-scale and in three dimensions. The best test of new work in the Village is whether or not it shows “good manners” towards its heritage neighbours and its neighbourhood.

The design Guidelines are divided into the following sections:

- 9.1 Architectural Styles, p. 55
- 9.2 Heritage Design & Details, p. 75
- 9.3 Existing Heritage Buildings, p. 88
Maintenance
Renovation
Additions
- 9.4 Existing Non- Heritage Buildings, p. 103
- 9.5 New Development, p. 105
Residential Areas
Yonge Street Commercial Core
- 9.6 Streetscape Work, p. 124
- 9.7 Landscaping, p. 130
- 9.8 Building Materials Checklists, p. 132

Architectural style means the identifying characteristics of construction as it has evolved under the force of changing technology and fashion. Before the industrial age, often minor details were custom-made for each building and it would be hard to find even two identical front door designs from the early 19th century.

Nonetheless, each period produced buildings that shared a design vocabulary, including elements of massing, composition, proportions, window and door details, and decorative elements. This section shows the principal styles that have appeared in Thornhill, both heritage styles and more recent ones. This section is necessarily brief and does not replace the real research needed for authentic work, as described in Section 9.3.2.

In the Guidelines that follow, reference is made to architectural styles for all types of buildings in Thornhill: existing heritage buildings, existing non-heritage buildings, and new development. The following pages show the characteristics of the local architectural styles.

Guideline:

Additions and alterations to an existing heritage building should be consistent with the style of the original building. New developments should be designed in a style that is consistent with the vernacular heritage of the community. All construction should be of a particular style, rather than a hybrid of many styles. Recent developments have tended to use hybrid designs, with inauthentic details and proportions; for larger homes, the French manor or *château* style (not indigenous to Ontario) has been heavily borrowed from. These kinds of designs are not appropriate for the Thornhill Vaughan Heritage Conservation District.

9.1 Architectural Styles

9.1.1 Heritage Styles Residential Buildings

VERNACULAR "LOYALIST" COTTAGE 1800-1850

Kitchen Tail often added later, sometimes with a side porch.

Fieldstone foundations

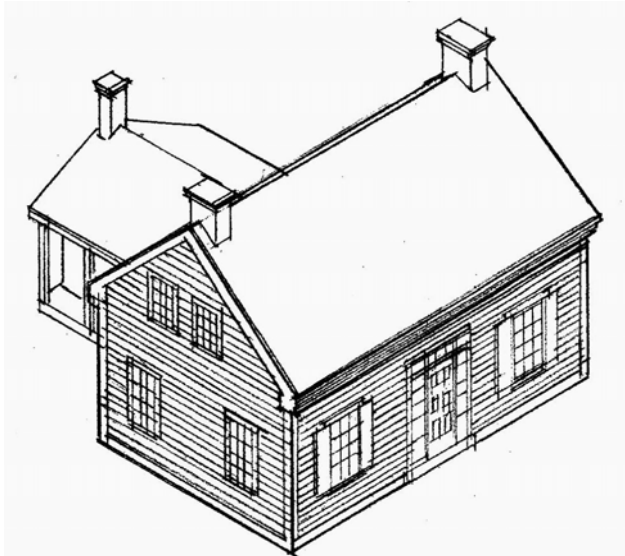

Brick chimneys, sometimes central

4" wood clapboard siding with wood corner boards; Brick or stone in some areas.

Wood fascia and eaves.

Symmetrical façade; central door with transom and/or sidelights.

Wood windows, double hung, 6 over 6 or greater.

Optional wood shutters.

The first of rural Ontario's two ubiquitous styles, the other being the Ontario Gothic Vernacular. The 1-1/2 storey design avoided the heavier taxation applied to 2-storey houses.

Typical Design Elements: for more information see Section 9.2

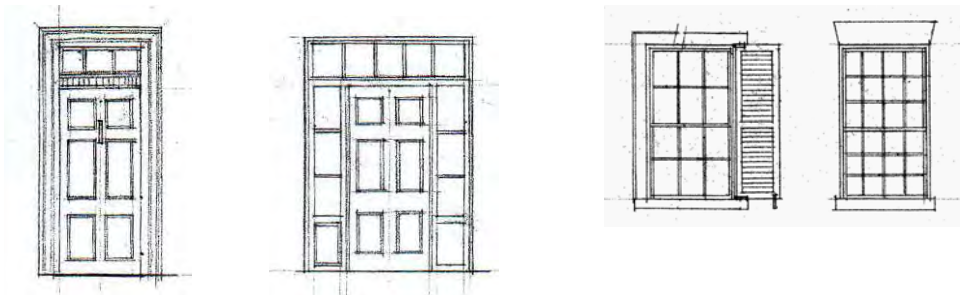

46 Centre Street

9.1 Architectural Styles

9.1.1 Heritage Styles Residential Buildings

NEO-CLASSICAL 1800-1830

Side gable roof with moderate slope

Brick chimneys at side walls

Fieldstone Foundation

Symmetrical front elevation

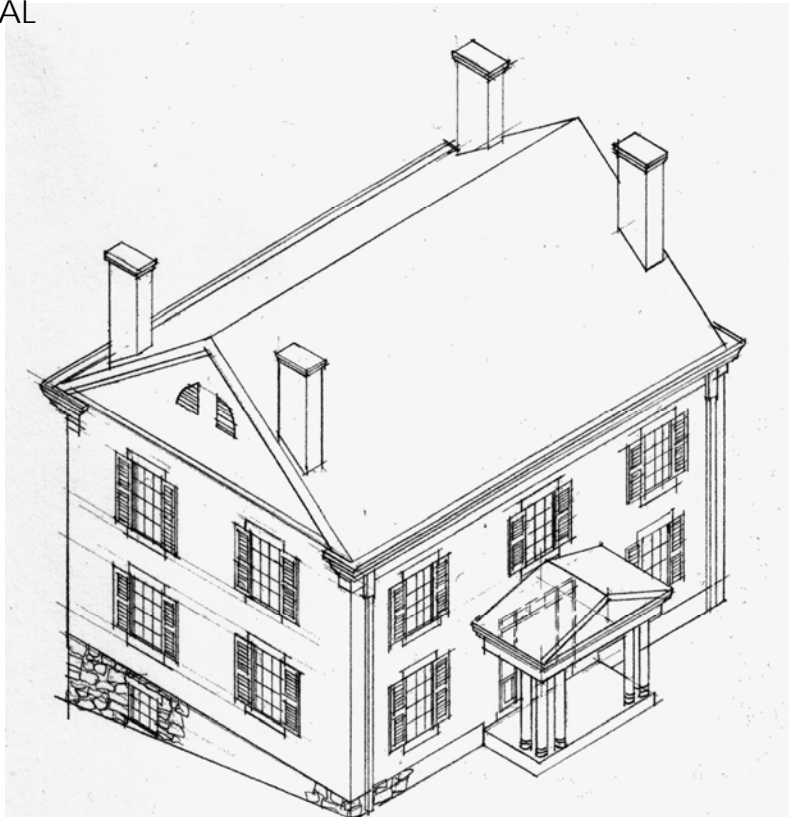

Usually brick or stone construction, less often wood clapboard.

Wood double-hung windows, often 12 over 12, tending to be larger than in Georgian style.

Classical details, such as pilasters at the corners, and "temple front" porch with classical columns.

Entry with sidelights and transom, often a fanlight. Classical surround is common.

Typical Design Elements: for more information see Section 9.2

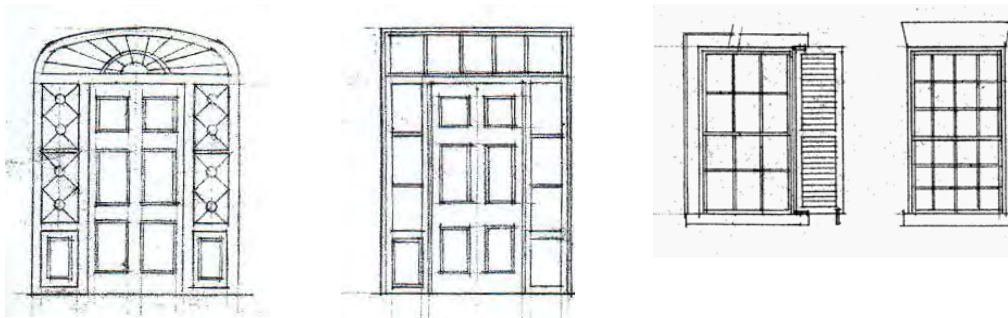

8000 Yonge Street

9.1 Architectural Styles

ONTARIO GOTHIC VERNACULAR 1830-1890

Kitchen Tail with room over.
Wood side porch with sheet metal roof.

Wood porch posts with decorative brackets.

Fieldstone foundations.

Red brick masonry with buff brick detailing—sometimes the reverse (polychromy).

Optional front verandah, often with bell-cast roof.

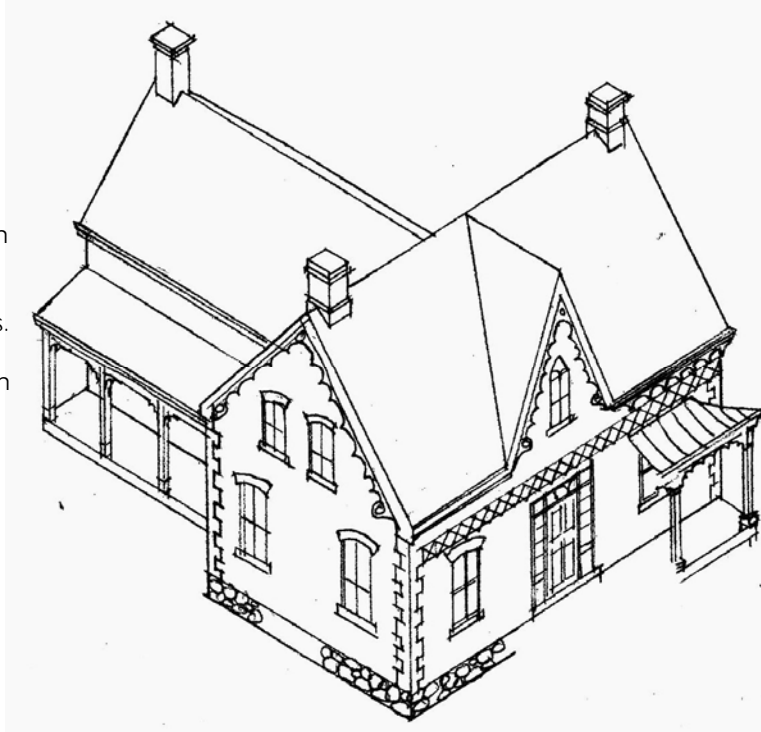

Brick chimney, corbelled polychrome.

Steep roof with "gingerbread" trim at gables; wood shingles or sheet metal roofing; Pointed 'gothic' window in central dormer gable.

Archetypal Ontario Gothic house, 1 1/2 storeys, commonly brick construction, but also built of stone, stucco, and board and batten wood siding.

Symmetrical façade; central door with transom and/or sidelights.

Segmental arch wood windows, double-hung, 2 over 2.

9.1.1 Heritage Styles Residential Buildings

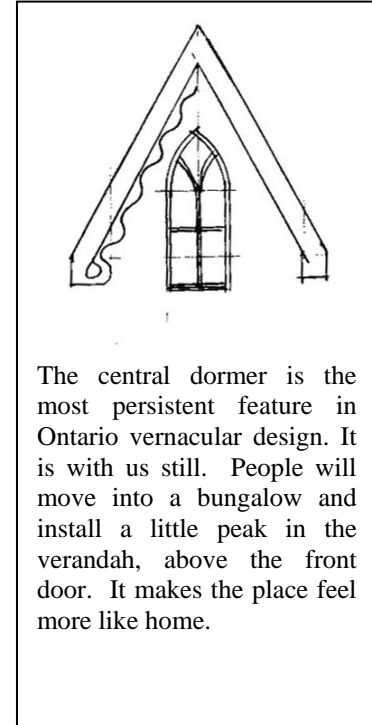

The central dormer is the most persistent feature in Ontario vernacular design. It is with us still. People will move into a bungalow and install a little peak in the verandah, above the front door. It makes the place feel more like home.

Typical Design Elements: for more information see Section 9.2

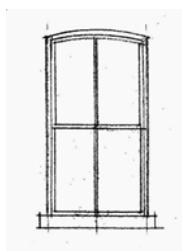
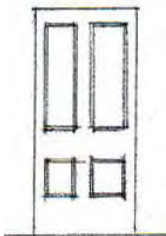

18 Centre Street

9.1 Architectural Styles

VICTORIAN VERNACULAR

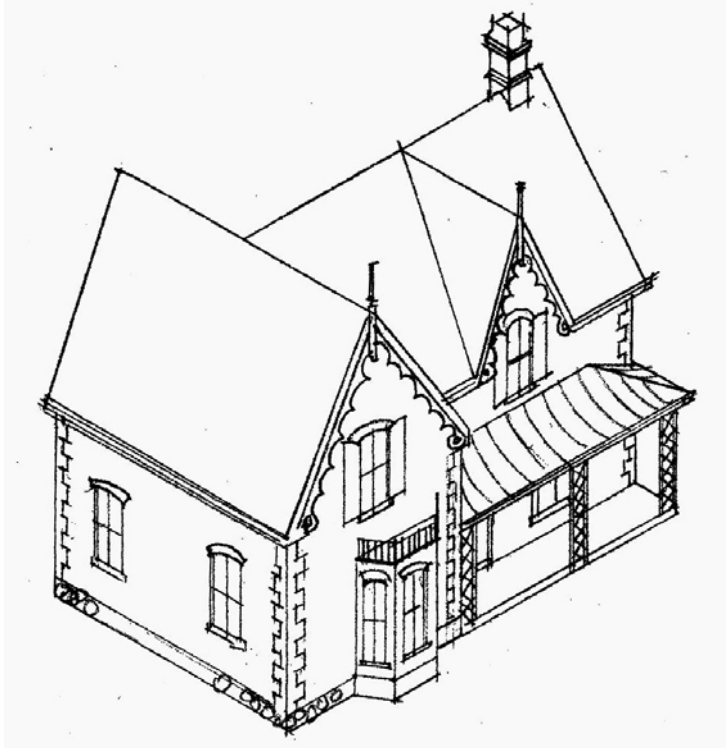

- Brick chimney, corbelled polychrome.
- Steep roof with "gingerbread" trim at gables; .wood shingles or sheet metal roofing; Pointed 'gothic' window in central dormer gable.
- Polychrome brick construction or board and batten siding (Carpenter Gothic).
- Asymmetrical façade, main front-gabled bay often has a bay window.
- Segmental arch windows, 2 over 2; optional shutters.
- Verandah with wood posts and decorative brackets, or trelliage.

9.1.1 Heritage Styles Residential Buildings

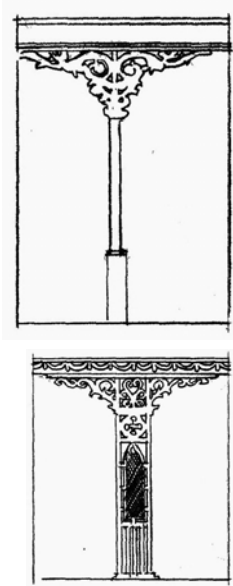

Typical Design Elements: for more information see Section 9.2

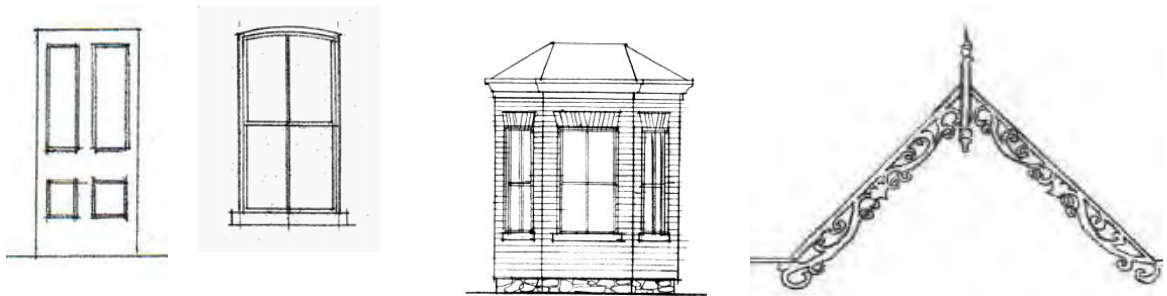

66 Centre Street

9.1 Architectural Styles

9.1.1 Heritage Styles Residential Buildings

QUEEN ANNE REVIVAL 1885-1900

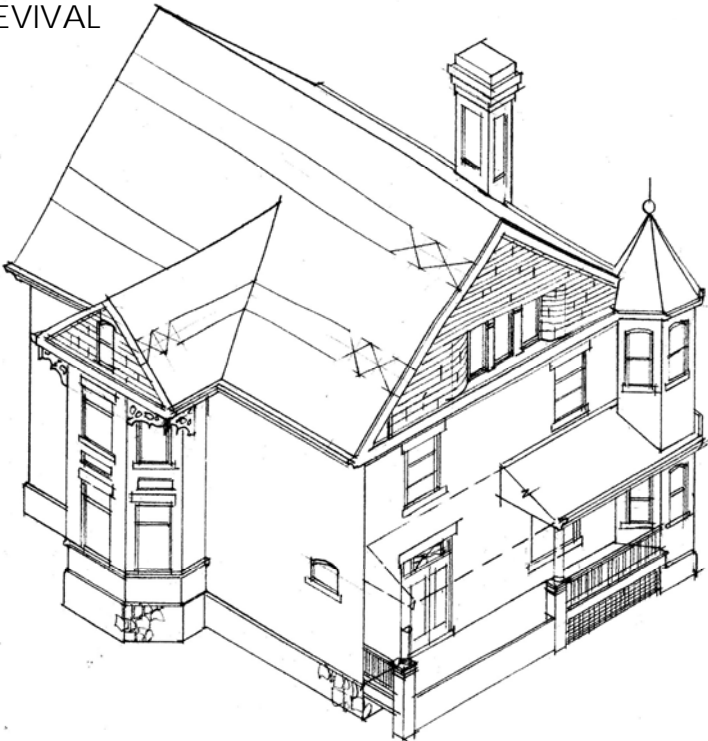

Steep gabled roof, often 12:12 slope.

Slate shingles often patterned.

Elaborate wood brackets, wood lattice work.

Brick construction.
Brickwork elaborately detailed.

Gable ends of shingles or tiles, often patterned.

Wide use of patterns in shingles, brickwork, and woodwork.

Asymmetrical plan, with turrets and bay windows.

Large double-hung windows, often with short upper sash.

Leaded and/or stained glass in transoms and upper sash.

Front porch or verandah.

Typical Design Elements: for more information see Section 9.2

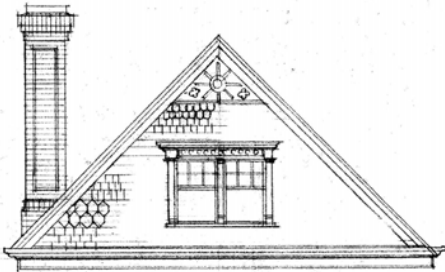
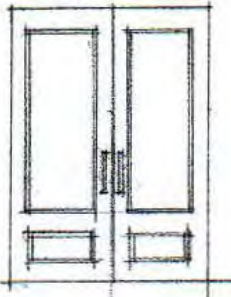
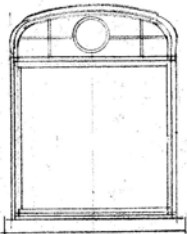

33 Centre Street

9.1 Architectural Styles

9.1.1 Heritage Styles Residential Buildings

VERNACULAR HOMESTEAD 1890-1930

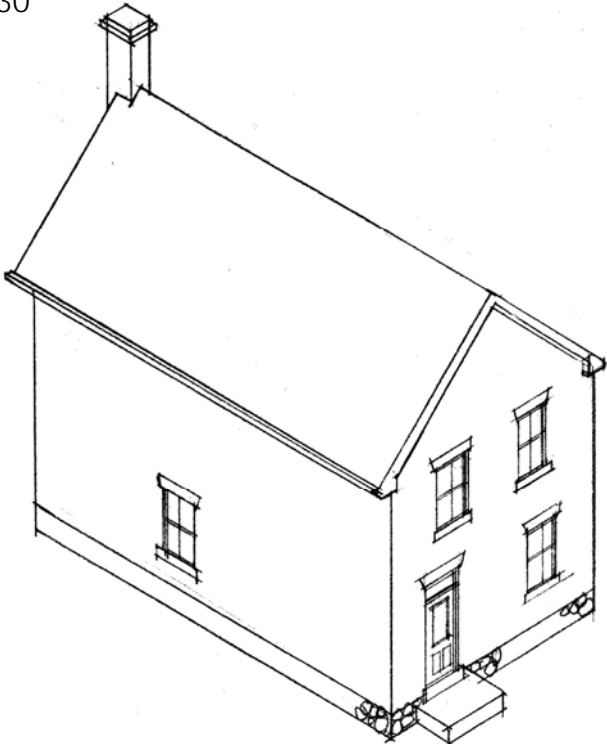

Front-facing gable with steep roof, 12:12.

Two bays wide, with entrance and stair to one side. Plan has greater depth than width.

Detailing is simple.

Full-width verandah is common

Square headed openings. Double-hung windows, 1/1 or 2/2.

May be clapboard, brick or stucco.

Typical Design Elements: for more information see Section 9.2

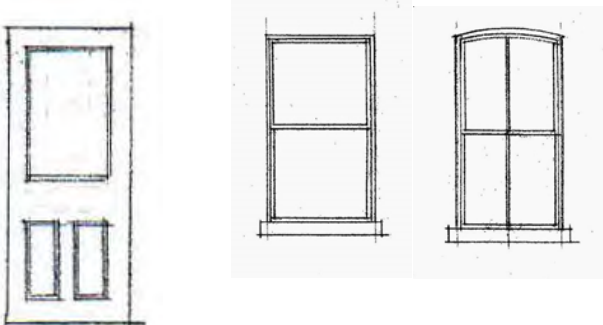

12 Elizabeth Street

9.1 Architectural Styles

9.1.1 Heritage Styles Residential Buildings

Four-square
1900-1920

Hipped 'cottage' roof with asphalt shingles.

Hipped-roof dormer .

Concrete Block Foundations.

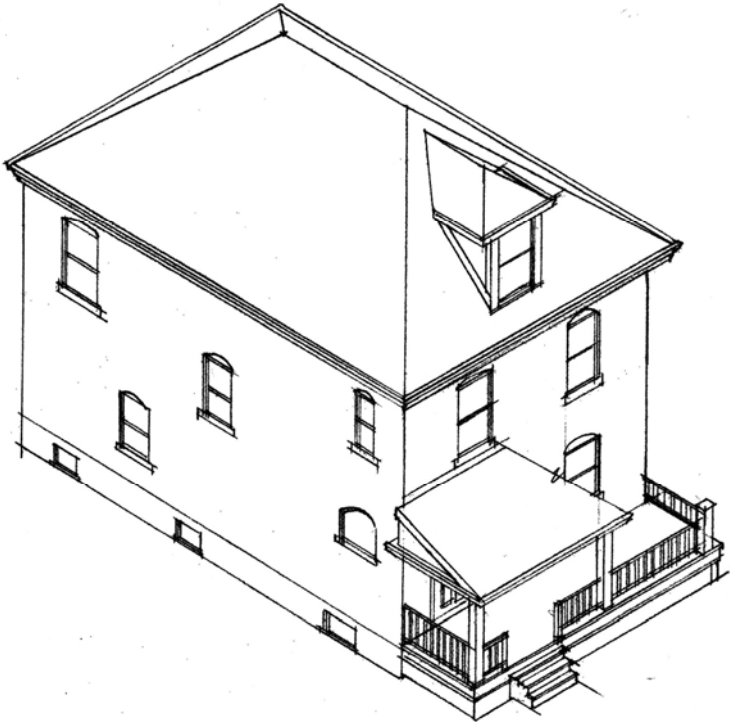

Brick construction.

Usually 2 bays wide with entrance to one side.

Wood double-hung windows, 1 over 1.

Simple wood porch or verandah.

Typical Design Elements: for more information see Section 9.2

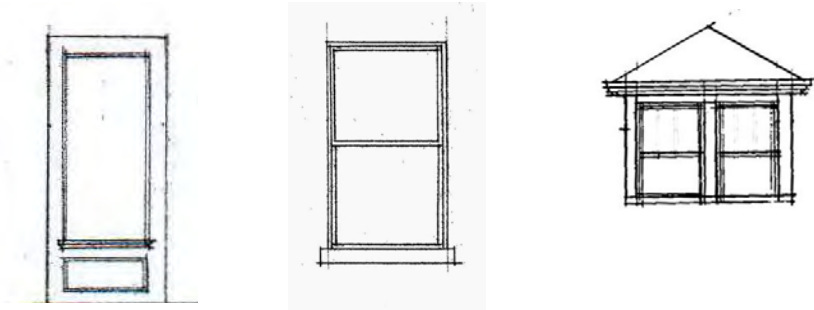

24 Elizabeth Street

9.1 Architectural Styles

9.1.1 Heritage Styles Residential Buildings

Edwardian
Classic
1900-1920

Low-slope hipped 'cottage' roof with asphalt shingles.

Hipped-roof dormer or low-slope gable in attic.

Non-symmetrical Plan and Façade.

Concrete Block Foundations.

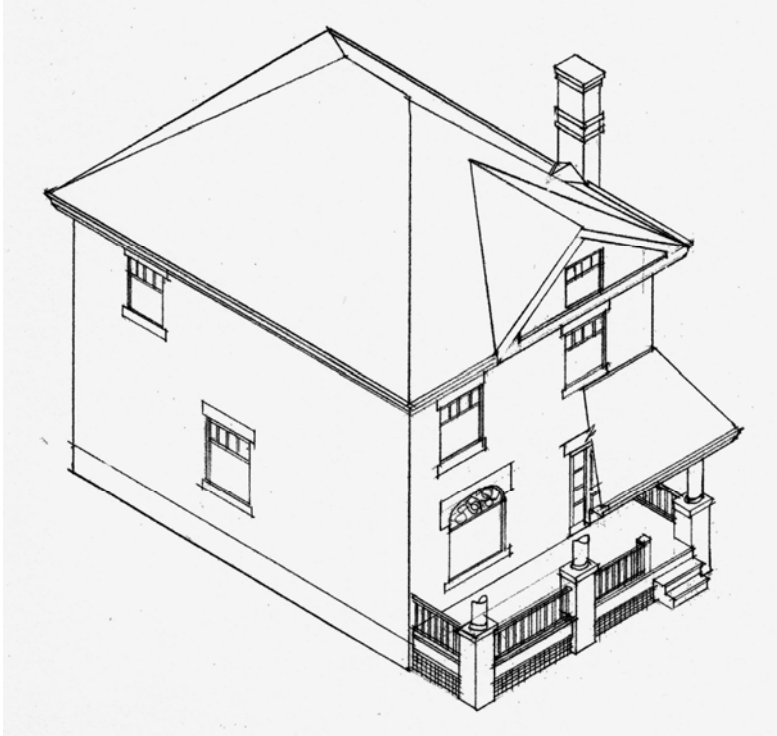

Brick construction. Elaborate brickwork.

Wide wood double-hung windows, often 6 over 1 or 4 vertical over 1. "cottage style".

Wood verandah with classical columns on brick piers.

Main front room window with decorative transom.

Typical Design Elements: for more information see Section 9.2

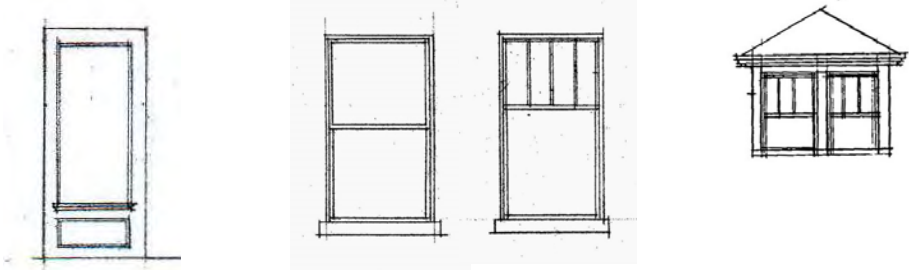

2174 Major Mackenzie Drive

9.1 Architectural Styles

A note on “Bungalows”.

The word “bungalow” has been applied to buildings of such a variety of sizes and shapes, that it causes architectural historians to shake their heads. John Milnes Baker, in his book *American House Styles*, says that bungalow is a type, not a style. In modern usage, the word has come to be used for almost any small house, regardless of its design. So there is some need to distinguish one kind of bungalow from another.

The term originates in a Hindi word meaning “house in the Bengal style”, and the originals were one-storey houses with low roofs and deep verandahs which provided needed airy shade in the heat of India.

The word entered the English language when the British in India adopted and elaborated the model for their army and colonial buildings, and they kept using the word as they built larger and fancier versions. The defining features remained the low roofs and the verandahs.

In North America, the term was first applied to small houses in the Craftsman style originally developed in California around 1900. These were 1- and 1-½ storey houses, with low-sloped roofs, wide eaves with the rafter tails exposed, and a deep front porch or verandah. Craftsman bungalow plans tended to be fairly open, with living and dining rooms flowing together, and perhaps a breakfast nook integrated with the kitchen.

The Craftsman bungalow was adopted as a model for mass-produced housing by builders across the continent between 1915 and 1930. The Builders’ bungalow retained the massing, but the Craftsman details were scaled back or eliminated.

By the late 1930s, “bungalow” had come to mean any small house that we don’t have another word for. The Cottage bungalow usually reverted to the hipped roof of the Bengali original, and in urban settings was sited with the narrow side facing the street. The Ranch bungalow (another California development) turned its long side to the street, on the larger lots of post-World War II suburbia.

The varieties of the North American bungalow are described in later sections.



The original version of the bungalow, this one in Ceylon.



A British colonial bungalow in India, 1896.



A very grand early 20th Century Bungalow in India.

9.1 Architectural Styles

ARTS AND CRAFTS 1900-1930

9.1.1 Heritage Styles Residential Buildings

Gable or
"Jenkins-head"
(partially hipped)
roof.

Bay windows
tend to be
square.

Brick or
Concrete Block
Foundations.

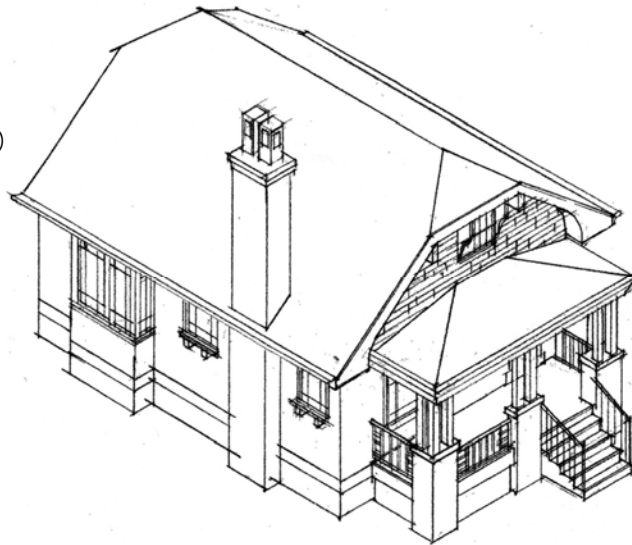

1 or 1-1/2 storey house.

Brick ground floor
construction is common,
with gable ends of cedar
shingles

Asymmetrical plan, with
entrance to one side.

Wood double-hung
windows. Elaborate
glazing patterns,
sometimes leaded.

Verandah is a dominant
design feature.

Rafter tails often
exposed, and cut into
decorative shapes.

Typical Design Elements: for more information see Section 9.2

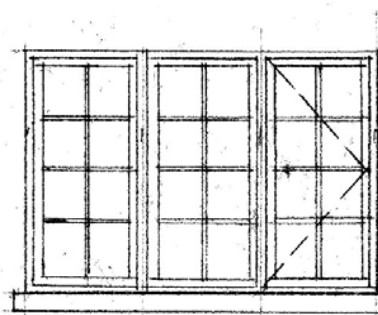

38 Centre Street

9.1 Architectural Styles

9.1.1 Heritage Styles Residential Buildings

CALIFORNIA BUNGALOW

Side gable roof, with long front slope covering full width verandah.

Wide front-gable dormer.

Concrete block foundation.

Non-symmetrical Plan and Façade.

Concrete Block Foundations.

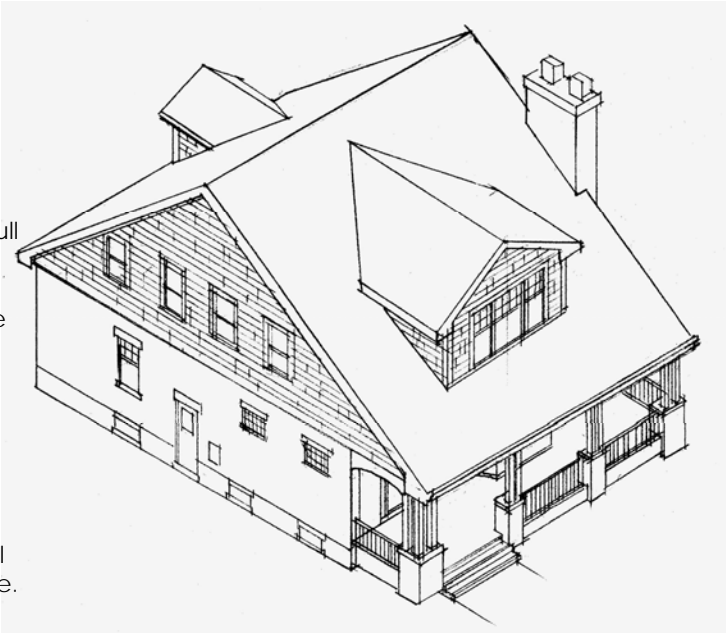

Usually brick ground floor, with cedar shingle gable ends and dormers.

Verandah usually supported by wood columns on masonry piers.

Wood double-hung windows, often 6 over 1 or 4 vertical over 1, "cottage style".

Typical Design Elements: for more information see Section 9.2

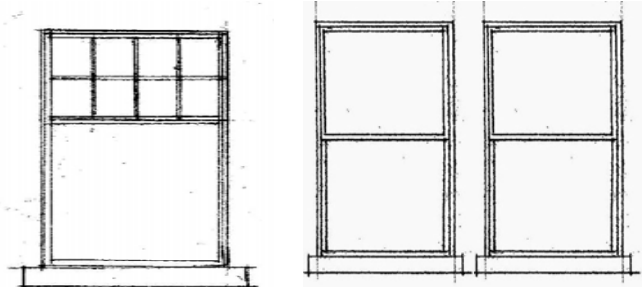

56 Centre Street

9.1 Architectural Styles

CAPE COD COTTAGE 1900-1930

9.1.1 Heritage Styles Residential Buildings

Steep side-gable roof 12:12 or more. Wood or asphalt shingles.

Large central chimney.

Optional dormers.

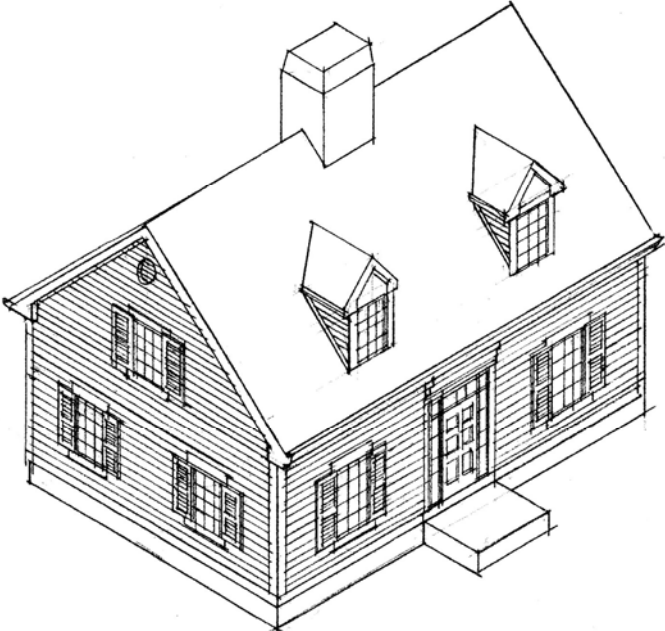

1-1/2 Storey house.

4" wood clapboard siding with corner boards and wood base and fascia.

Brick or stone in some areas.

Usually centre hall with symmetrical façade. Entry with sidelights.

Wood double-hung windows, 6 over 6. Louvered wood shutters.

Typical Design Elements: for more information see Section 3.

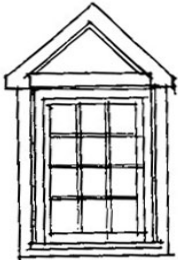
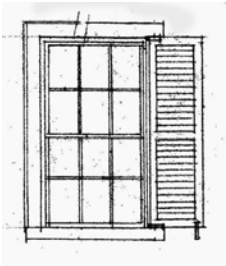
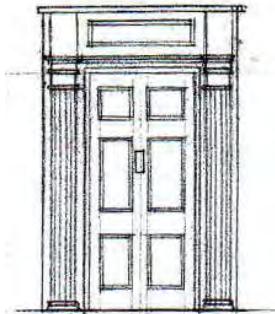

109 Centre Street

9.1 Architectural Styles

HOTELS AND INNS 1850-1880

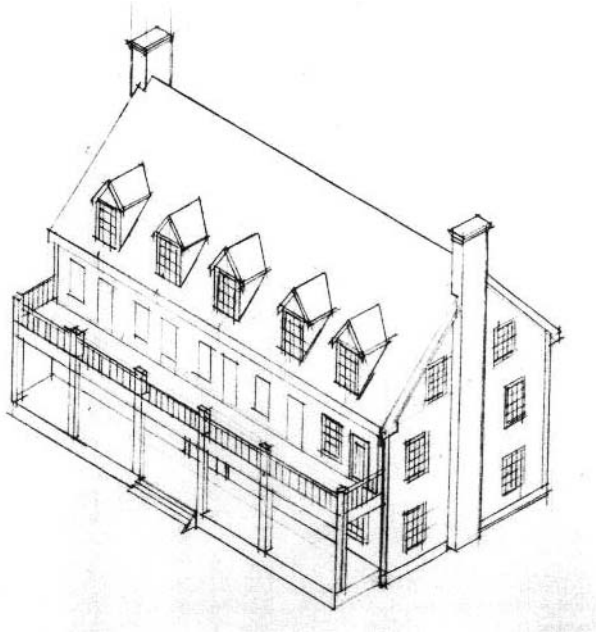

Usually 2 or 3 storeys with full-width front porch—commonly with balconies above.

Usually frame construction in villages, sometimes brick in larger towns.

Side-gable roof was most common, with optional dormers.

Usually there was a stable alongside, for the travellers' horses and wagons .

9.1.2 Heritage Styles Commercial Buildings

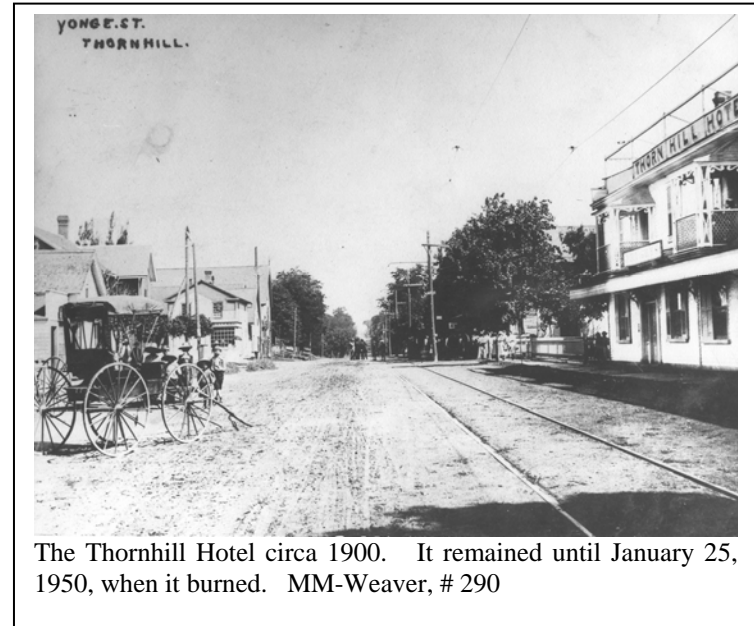

The Thornhill Hotel circa 1900. It remained until January 25, 1950, when it burned. MM-Weaver, # 290

9.1 Architectural Styles

VERNACULAR VILLAGE SHOP 1850-1910

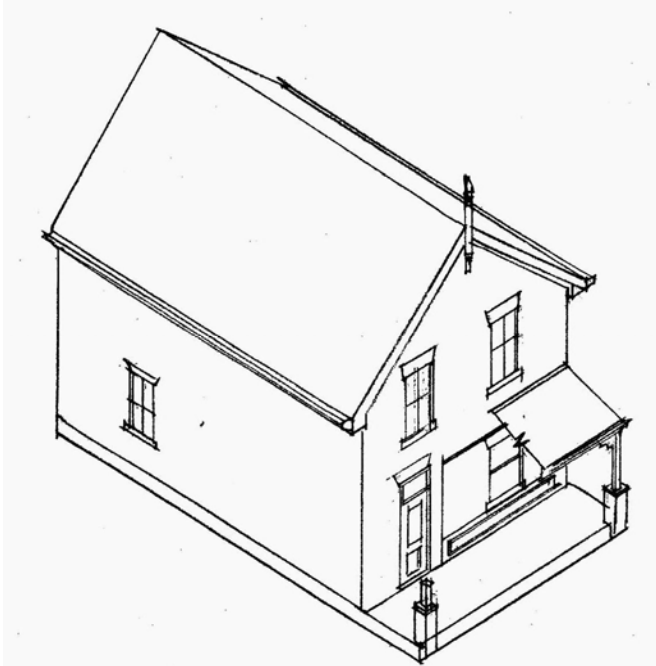

Usually a front-gabled frame building, similar to a homestead house. Often built with a false-front (boomtown style).

Typically built with shop below and living quarters above or behind.

Display window ranged from a slightly wider ordinary window, to a full-fledged shop-front as found in town shops.

Front porch, perhaps with sign on top, was very common.

9.1.2 Heritage Styles Commercial Buildings



The McDonald Store on the right, just south of Centre Street on the Markham side of Yonge Street. It was demolished in 1971.
MM-Weaver #280

Typical Design Elements: for more information see Section 9.2

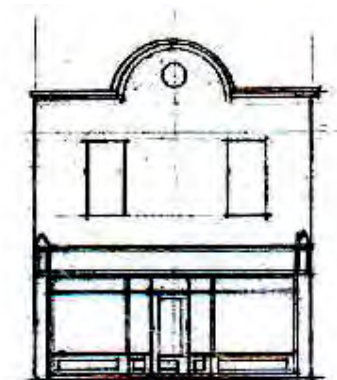
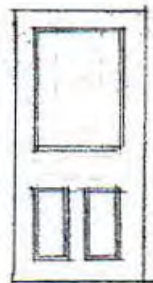
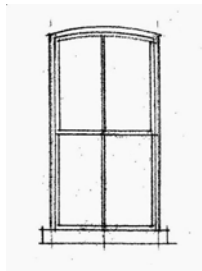

9.1 Architectural Styles

VERNACULAR TOWN SHOP 1880-1910

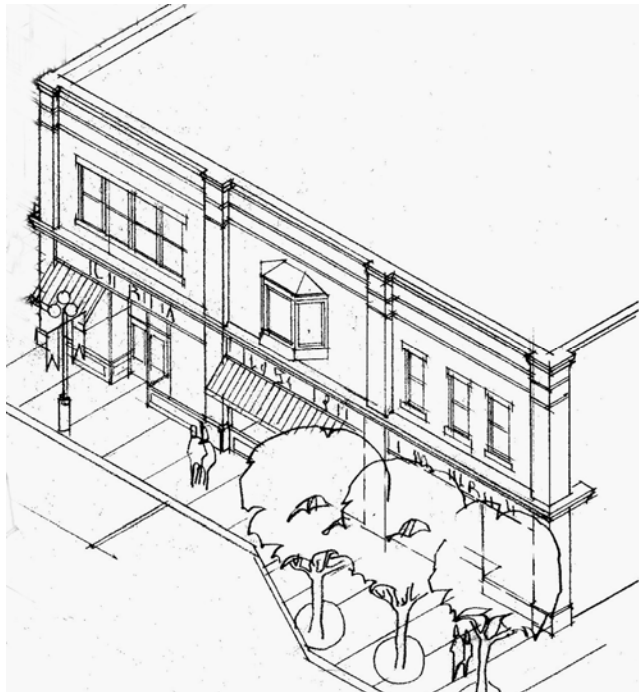

Two to three-storey buildings.

Early town shops might be wood-framed, but brick construction was more common by 1880, after many town fires throughout Ontario.

Built with uniform frontage at the street line.

Usually with flat roofs, sometimes with shallow side gable design.

Taller ground floor with high display windows, and full-width sign fascia above. Large retractable awnings.

9.1.2 Heritage Styles Commercial Buildings

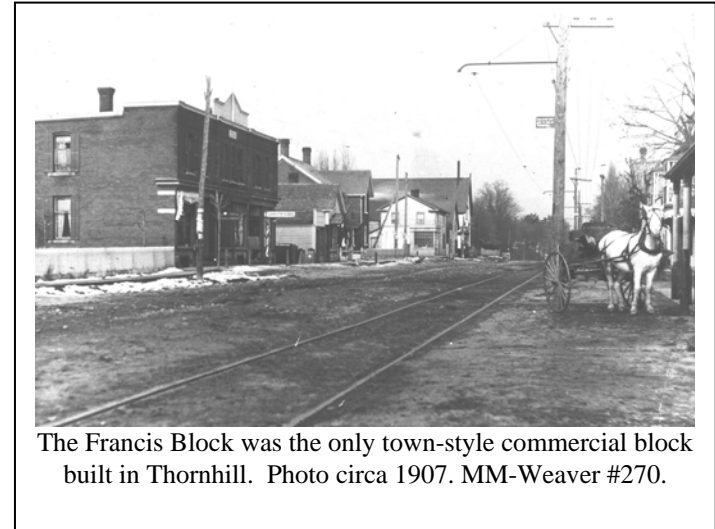

The Francis Block was the only town-style commercial block built in Thornhill. Photo circa 1907. MM-Weaver #270.

Typical Design Elements: for more information see Section 9.2

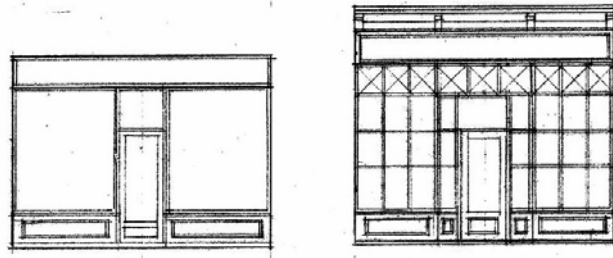

The Francis Block today, 7716-7724 Yonge Street.

9.1 Architectural Styles

GABLE- ROOFED TOWN-BARN OR
STABLE SHOP
1850-1920

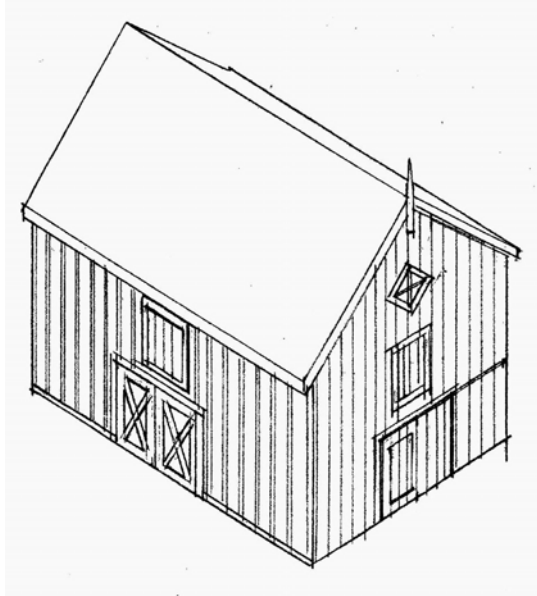

High-slope roof, wood shingle or sheet metal.

Timber frame with vertical wood siding, often slightly spaced for ventilation. Sometimes board and batten.

Upper loading door for hayloft. Sliding or hinged main lower doors, often with a smaller "man door" within it.

9.1.3 Heritage Styles Agricultural Buildings



Town barn behind 12 Centre Street

9.1 Architectural Styles

VERNACULAR
BUNGALOW
1900-1955

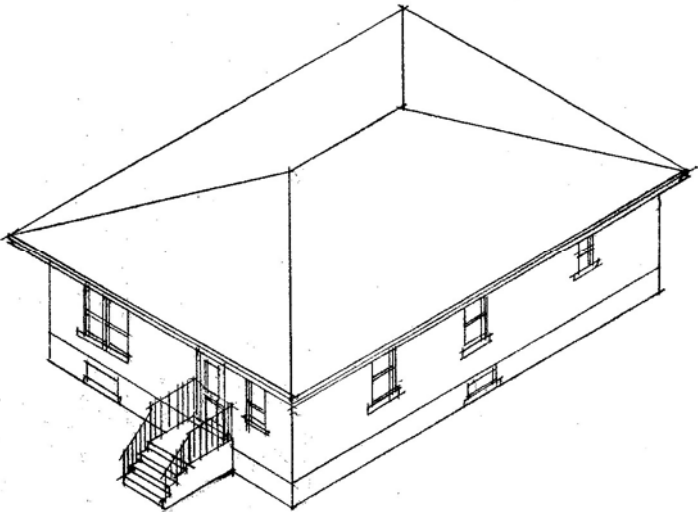

Brick or frame construction.

Low slope roof, hipped or front-gable.

Wood double-hung windows, usually 1 over 1. Sometimes paired. Living room often had a "picture" window, with a wide fixed-glass window flanked by 2 narrow double-hung windows.

See "A note on bungalows", page 68.

9.1.4 Non-Heritage Styles Residential Buildings

Typical Design Elements: for more information see Section 9.2

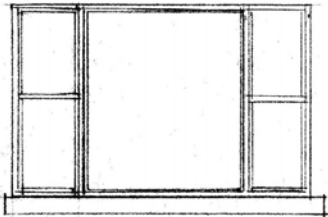
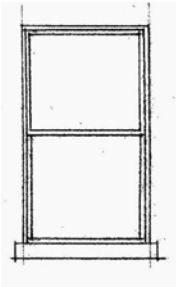

137 Brooke Street

9.1 Architectural Styles

9.1.4 Non-Heritage Styles Residential Buildings

RANCH HOUSE 1950-1975

Low slope roof,
4:12, hipped or gabled.

Asphalt Shingles.

Wide eaves,
with 2-4 foot
overhang.

Large Chimney.

Often accent
bands of stone or
'angel stone.

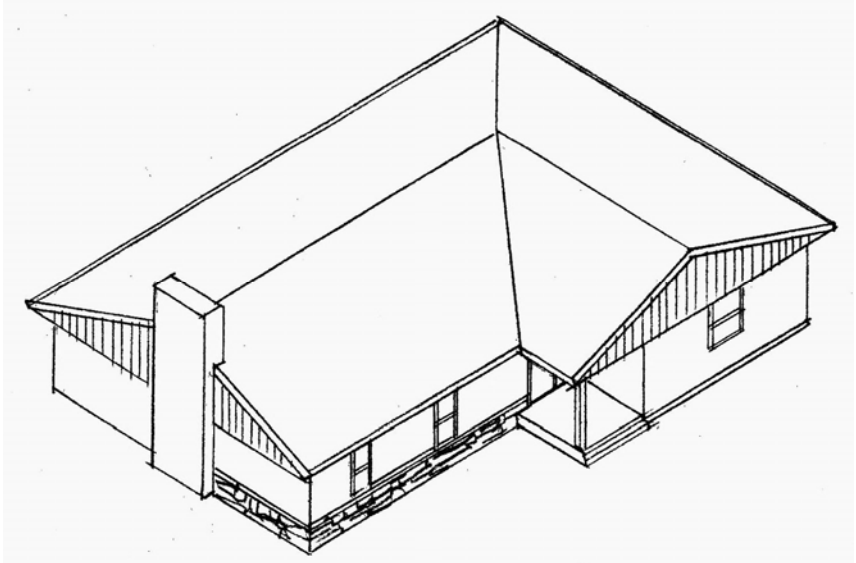

One-storey,
informal plan.

Garage or carport
usually attached.

Usually brick veneer
on frame
construction.

Large fixed picture
windows in
principal rooms,
flanked by
operable windows;
double hung or
casement.

Typical Design Elements: for more information see Section 9.2

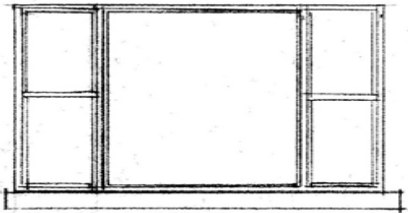
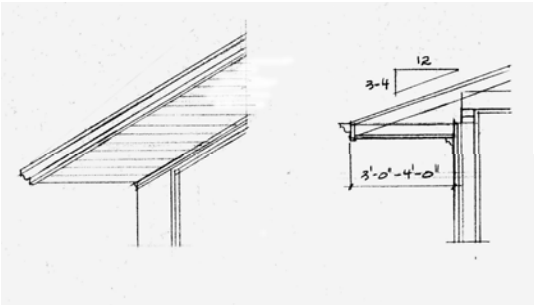

18 Mill Street

9.1 Architectural Styles

POST MODERN
ECLECTICISM
1980 TO PRESENT

9.1.4 Non-Heritage Styles Residential Buildings

Large high-sloped
roof.

Usually two storeys
high.

Elaborate chimneys
are common.



Architectural elements
borrowed from a variety
of historical style.
Elements are typically
exaggerated in scale,
particularly entrances,
fanlights, and porches.

Mixture of materials:
Stone base with brick or
stucco above is
common.

Attached or built-in
garages are common.



148 Brooke Street

9.2 Heritage Design and Details

9.2.1 Introduction

The purpose of this Section is to provide further information and guidance about the design and construction of heritage buildings.

9.2.2 Composition

The elevations of heritage buildings, whether designed by an architect or by a builder using a “pattern book”, were usually laid out using geometrical principles and geometrically derived proportions. Knowledge of how heritage buildings were originally composed can be helpful in designing a new building that will fit well in the heritage context. Helpful sources of information are listed in Section 10.

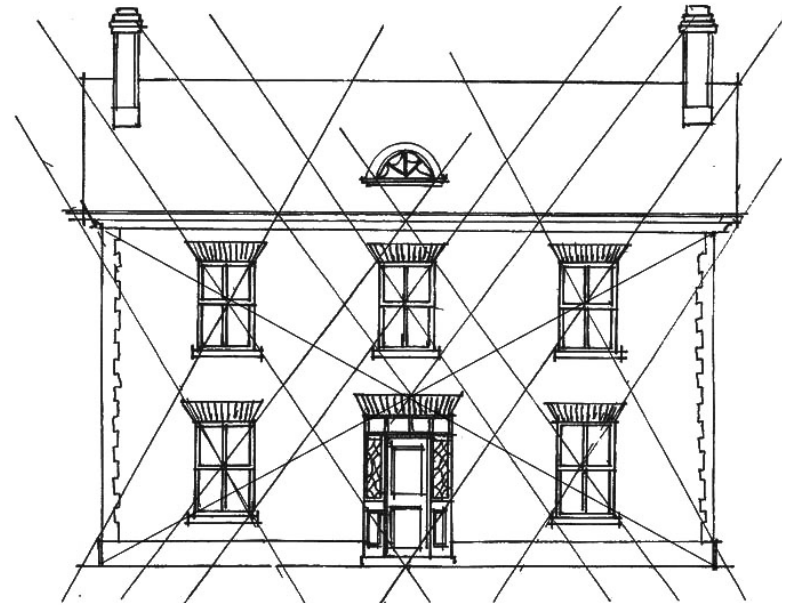

Geometry governed most heritage design. In this example, from Black Creek Pioneer Village, the diagonals of the window openings relate to significant elements in the elevation and to each other. The diagonals of the main wall relate to the windows and front-door keystone, as well.

If a building is pleasing to the eye, it is probably rich in such relationships.

Drawing by Steven Bell.

9.2.2 Composition Cont'd

The proportion of windows to walls and the proportions of individual window openings and window panes are an important aspect of composition.

Traditionally, windows are between 15 and 20 percent of a wall, and windows are taller than they are wide, usually with a ratio of 2:1 or more. In most heritage styles, individual window panes are also taller than they are wide.

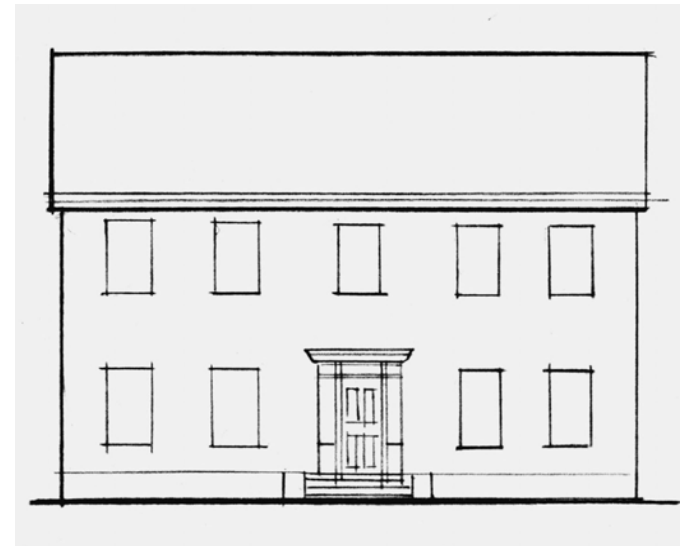

Appropriate: 15 to 20% opening is historically correct.

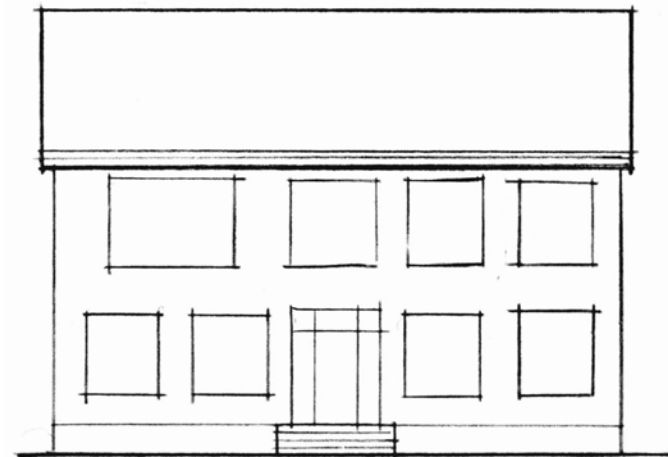

Inappropriate: 30 to 40% is excessive.

9.2 Heritage Design and Details

9.2.3 Entrances and Doors

Entrances in heritage buildings are usually provided with some elaboration. In the simplest Georgian cottages this might only consist of fluted casings and a simple cornice, but a plain transom above the door was common.

Later styles made use of sidelights as well, which always had solid panels below the glazing.

The proportional scheme of the building governed the design, so that even ornate entrances did not overwhelm the building.

Entrance doors were not glazed until the Victorian era.

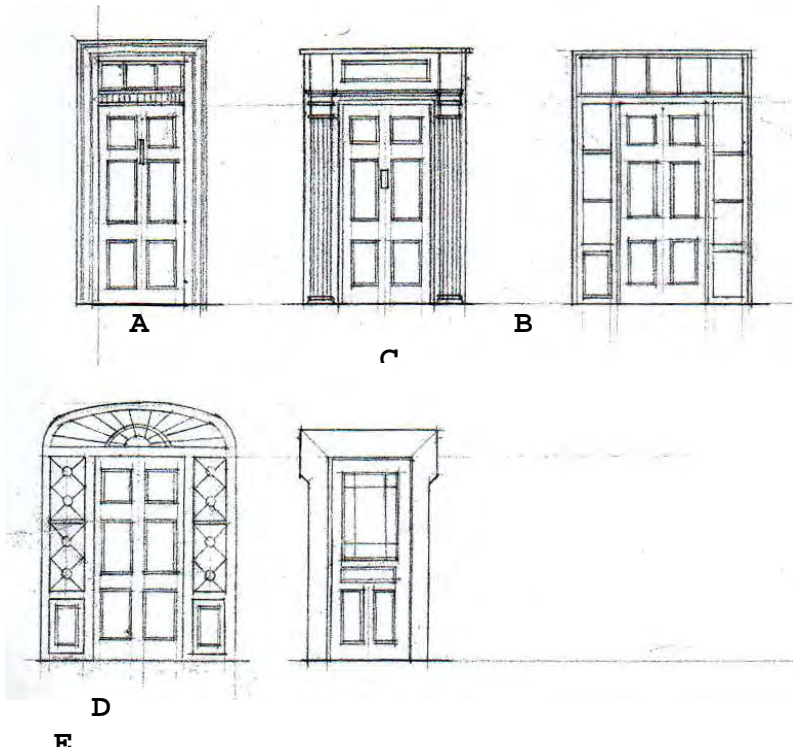

- A. Solid panel door with transom and wood casing.
- B. Solid panel door with classical cornice.
- C. Solid panel door with transom and sidelights.
- D. Solid panel door with decorative sidelights and fanlight transom.
- E. Wood panel door with decorative glazing and eared casing.

9.2 Heritage Design and Details

9.2.3 Entrances and Doors Cont'd

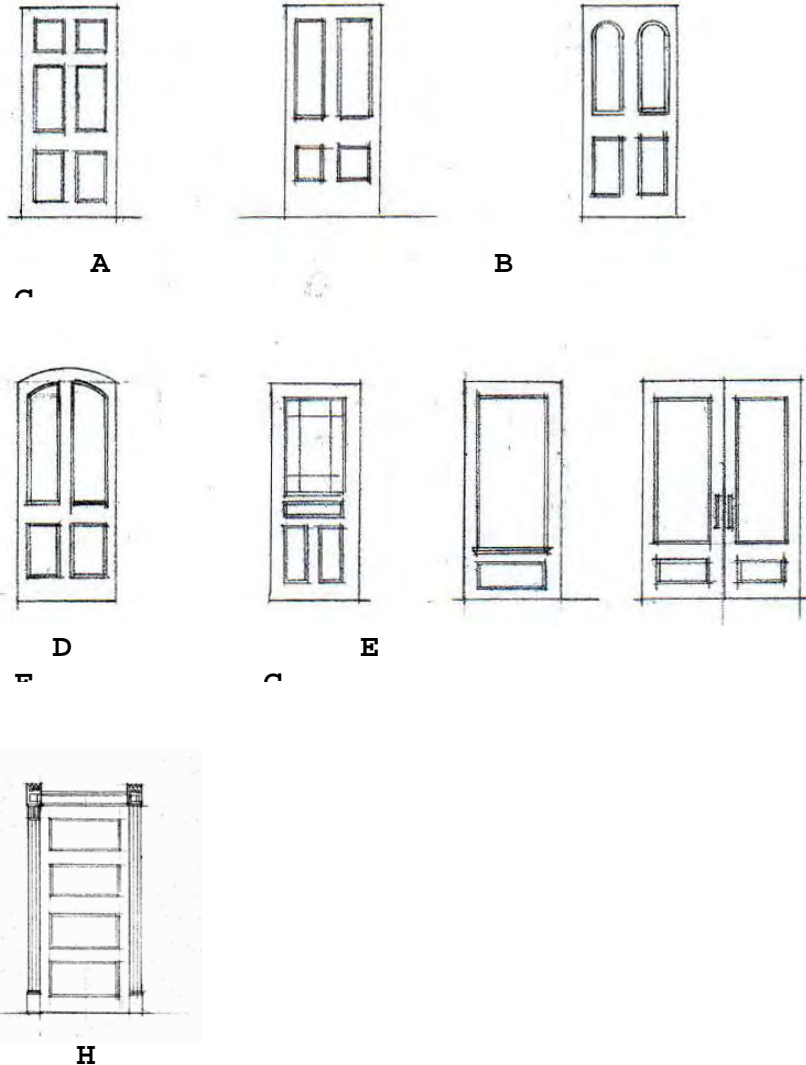

Log-cabin pioneers built simple plank doors, such as you would find on a barn, but as soon as skilled workers became available, doors were built in frame-and-panel construction.

Georgian doors tended to have 6 panels. The example shown at the top left is called a 'Cross and Bible' door, because the rails between the top four panels form a cross, and the two panels below are said to be an open book.

Later styles used 4-panel doors, with very tall top panels. These provide a vertical emphasis, in keeping with the Gothic Revival, Victorian Vernacular, and Italianate styles.

In the late 19th and early 20th centuries, the horizontal emphasis of Edwardian and Arts and Crafts styles led to doors with horizontal "ladder" panelling.

When large pieces of glass became available, around 1850, doors began to be glazed. In the simplest case, the two upper panels of a 4-panel door would receive glass, but the ability to glaze the full width of a door led to a variety of panel designs.

- A. Cross and Bible Door
- B. Four Panel Door
- C. Arched Panel Four Panel Door
- D. Arched-head Four Panel Door.
- E. Glazed Wood Panel Door.
- F. Glazed Wood Shopfront Door.
- G. Paired Glazed Wood Shopfront Door.
- H. Four Panel "Ladder" Door

9.2 Heritage Design and Details

9.2.4 Windows and Shutters

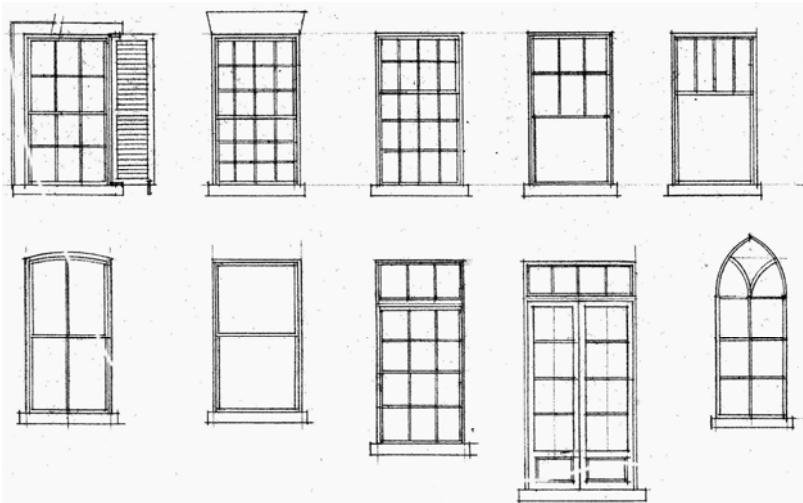

Shutters were provided to secure windows from storms and damage, and they were designed and installed to close the window opening. They are hinged at the window jamb, and each shutter covers exactly half of the opening. Usually they were louvred.

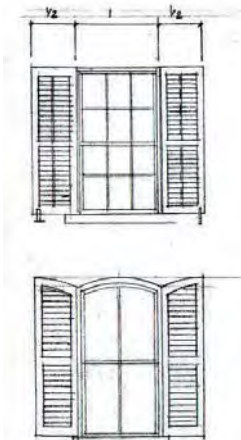

Most heritage styles used double-hung windows. These are described by the number of panes, or lights, in each sash. If there are 6 panes above and 6 below, it's called a 6 over 6, or 6/6 window.

Before around 1850 the size of available panes was small, and the number of lights was large. Typical Georgian windows were 12/12. As glass technology improved, larger glass led to 2/2 and then 1/1 windows.

Later styles, such as Edwardian and Arts and Crafts, made use of both large and small lights, and 6/1 and 8/1 windows became common.

As a general rule, windows had more height than width, and the individual lights shared that vertical proportion. Glass that is wider than it is high is found only in very wide single light sash.

Casement windows appeared in only a few styles. Some Regency windows could be called casements, though they are more like French doors, with sills barely above the floor. The Craftsman and Arts and Crafts styles were the first to use what we would call casements today.

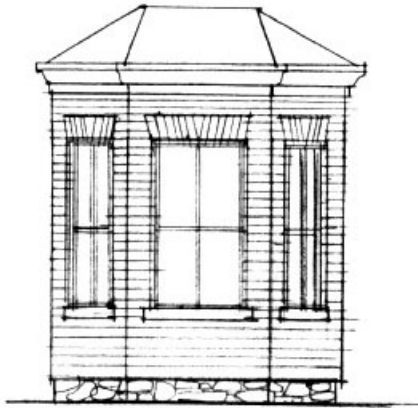

Victorian

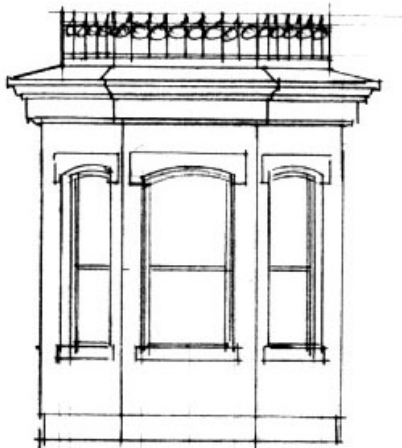

Victorian, Italianate,
Second Empire

9.2.5 Bay Windows

Bay Windows provide visual interest on the exterior and create a well-lighted nook on the interior. They appear on a number of historic styles, but not all. There is a tendency to overuse them in new buildings, when they are not appropriate to the overall architectural style. Care should also be taken to use window shapes and glazing patterns suitable to the overall architectural style.

Most bay windows in most styles are angled, usually at 45 degrees, but the Arts and Crafts style, and some Victorian Vernacular buildings used square bays.

In Thornhill, bay windows are typically on the ground floor only, and extend to the ground. Some Arts and Crafts houses have square bay windows that don't extend to the ground, as can be seen on two houses on the Markham side of the village.

9.2.6 Gable Ends



Classical Styles



Victorian Gothic



Queen Anne Revival
Gable Peak

The classically-based styles, such as Georgian and Classical Revival used fairly plain bargeboards. A plain board, with perhaps a small ogee moulding on the upper edge, was the most common design. The eaves would include a wooden gutter in the shape of a wide ogee-moulding. This shape was later replicated by sheet-metal eaves-troughs. Below this was usually a fascia board, sometimes with additional moulding at the top, or perhaps dentils. The fascia and mouldings typically turned the corner at the gable end as shown in the upper sketch, in what is called an eaves return.

The Victorian Gothic styles used elaborate bargeboards in a wide variety of forms—what has come to be called “gingerbread”. Sometimes these were sinuous shapes cut out on a scroll saw. In other cases pierced patterns were cut into a simpler board. A common feature was a finial at the peak, as shown in the middle sketch. There are often characteristic local styles in Victorian trim, and in Thornhill the bargeboards are typically cut in an open, sinuous pattern.

It is good practice to repair or replace historic gingerbread in the original pattern, using accurate dimensions. Historic drawings or photographs, or nearby local examples can be used as sources for an authentic design.

The Queen Anne Revival style tended to use built-up detail, with square panels and round medallions applied to a plain bargeboard. The peak of a gable was often given an ornate decoration of built-up work, as shown in the lower sketch.

9.2 Heritage Design and Details

9.2.7 Dormers

Dormers provide useful light in attic spaces, and as described in Section 9.1, the use of an attic avoided the higher taxes on a two-storey house in the early 19th Century.

Victorian Gothic dormers rise from the main wall of the house, and are not set back from the roof. When the bargeboard meets the main eaves they are usually considered gables rather than dormers.

Thornhill styles that might have originally had dormers include Queen Anne Revival, Foursquare, Edwardian, Craftsman/Arts and Crafts, California Bungalow, and Cape Cod Cottage. When designing new dormers, care should be taken that they are appropriate to the architectural style in all details: roof slopes, fascias, soffits, window shapes and glazing.

Large shed dormers, extending almost the full width of a house were not used in historic styles, and should be only used on rear slopes not visible from the public realm.

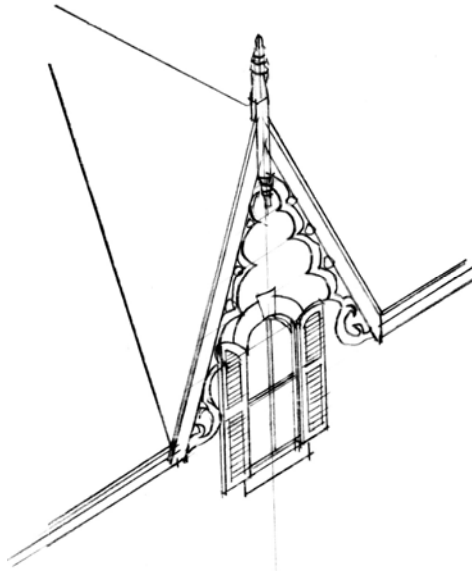

Victorian Gothic.

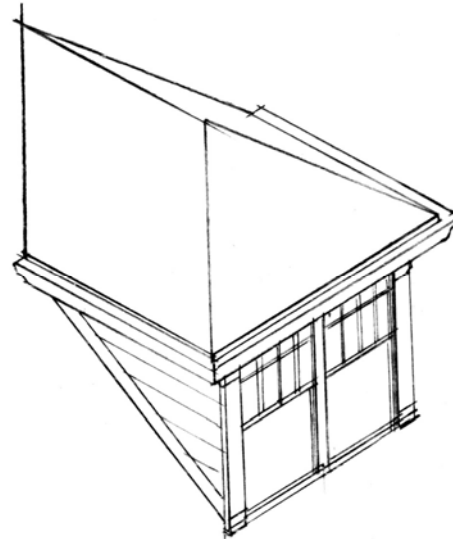

Edwardian.
Foursquare is similar, but uses simple
1 over 1 glazing.

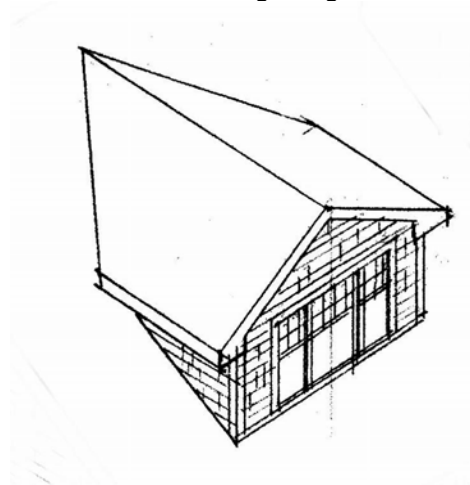

Arts and Crafts/California Bungalow.

9.2 Heritage Design and Details

9.2.8 Porch Design

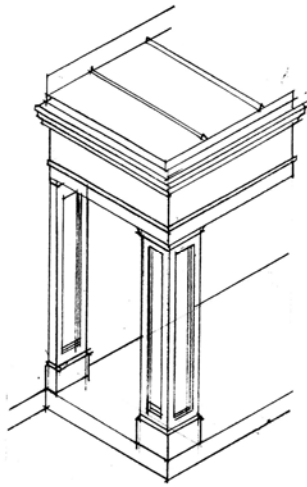

Georgian/Neoclassical

Wood columns, round or square classical design.

Columns may be plain or fluted.

Flat metal roof or front-facing pediment.

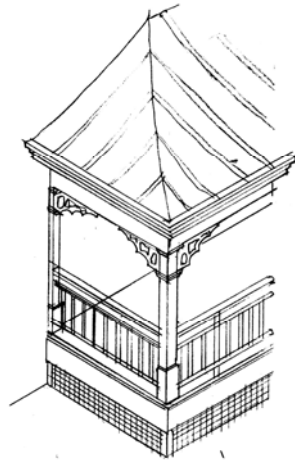

Victorian Gothic

Wood columns, often turned.

Ornate "gingerbread" brackets.

Often with metal roof, often "bell-cast" shape.

Balusters on railing usually square.

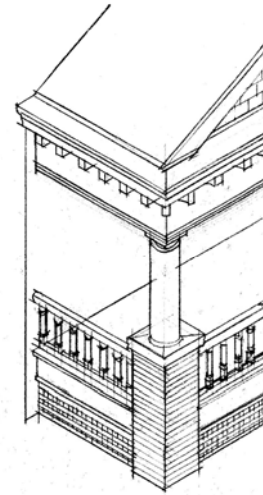

Edwardian Styles

Classical columns on stone-capped brick piers.

Front-facing pediment or hipped shingle roof.

Classical detailing like column capitals and dentils.

Balusters on railing turned or bellied.

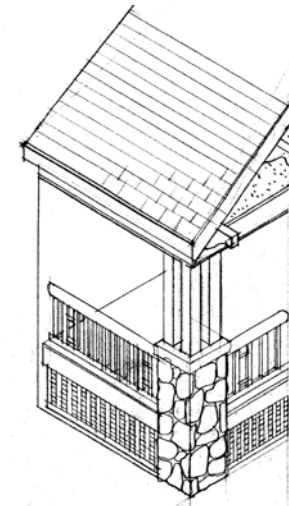

Arts and Crafts

Rustic timber columns, often clustered, often on rubble base.

Sense of exposed carpentry, with exposed joist tails, often cut to form a bracket.

Balusters often installed with thin face outward, often bunched in groups of 2 or 3.

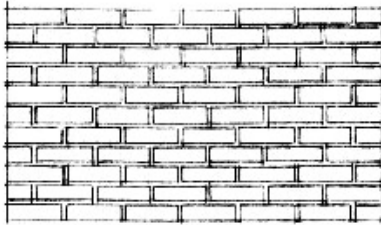

Running Bond

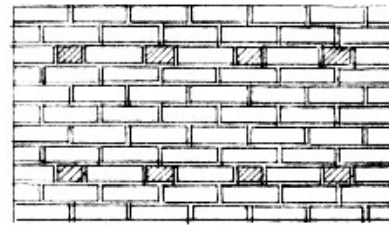

Common Bond

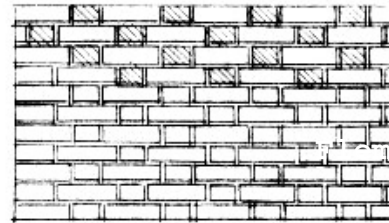

Flemish Bond

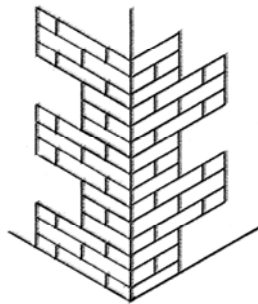

Correct Quoining

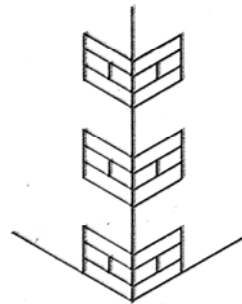

Incorrect Quoining

9.2.9 Brickwork

Historic brick walls were solid masonry, and in order to carry the weight of floors and roofs they were two or more bricks thick. It was structurally necessary to tie the inner and outer wythes together, and the simplest and surest way to do this was to put headers across the thickness of the wall at some regular interval. The pattern in which the bricks are laid is called the “bond”.

Modern brickwork is usually a veneer in front of a frame or concrete block structural wall. The veneer is typically tied to the structure with metal ties, and there is no structural need for headers. Because it's quick and easy, the running bond, shown at upper left, is commonly used for modern brick veneer walls.

Historic bonds, which use headers, provide a subtle but lively texture to a wall. The cost of laying one of the historic bonds by using half-bricks to replicate the headers is extremely small, and it is a simple way to maintain heritage character in new construction.

Brick quoins imitate larger stone quoins, which interlock to strengthen the corner of a building. A quoin block has a short side and a long side, and brick quoins should be laid in the same form, as shown in the sketch on the left. The sketch on the right shows what not to do.

9.2 Heritage Design and Details

9.2.9 Brickwork Cont'd

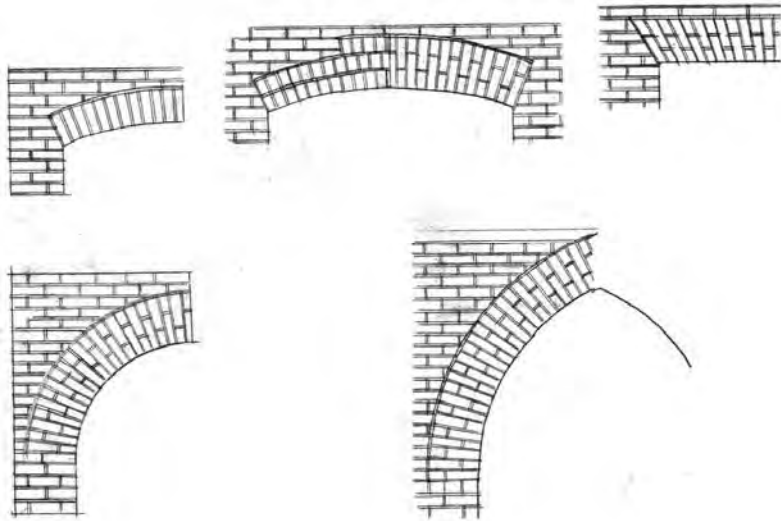

Before the use of iron and steel in construction, lintels over structural openings in brick walls were either solid stone or brick arches. Modern construction commonly uses steel lintels, hidden by the brickwork. To create an authentic appearance, the bricks should be laid to replicate historic structural arches. It is common practice to use a simple soldier course above an opening, without the outward slant that provides arch action in an authentic arch.

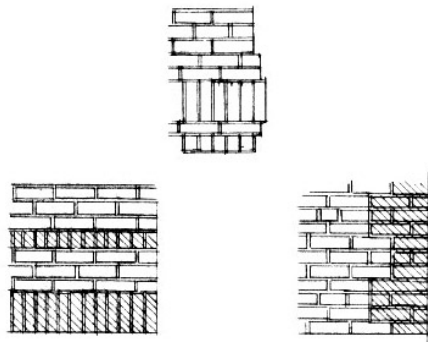

Victorian and Queen Anne Revival brickwork was rich in colour and pattern. Projecting and recessed courses, the use of headers, rowlock, and dogtooth courses, and contrasting quoins were all used to enliven masonry. It's not unusual to find designers limiting themselves to quoins and soldier courses. However, when working in the vocabulary of historic styles, it is more authentic to make use of the full variety of historic brickwork. Some manufacturers provide shaped bricks, which were also part of many historic styles.

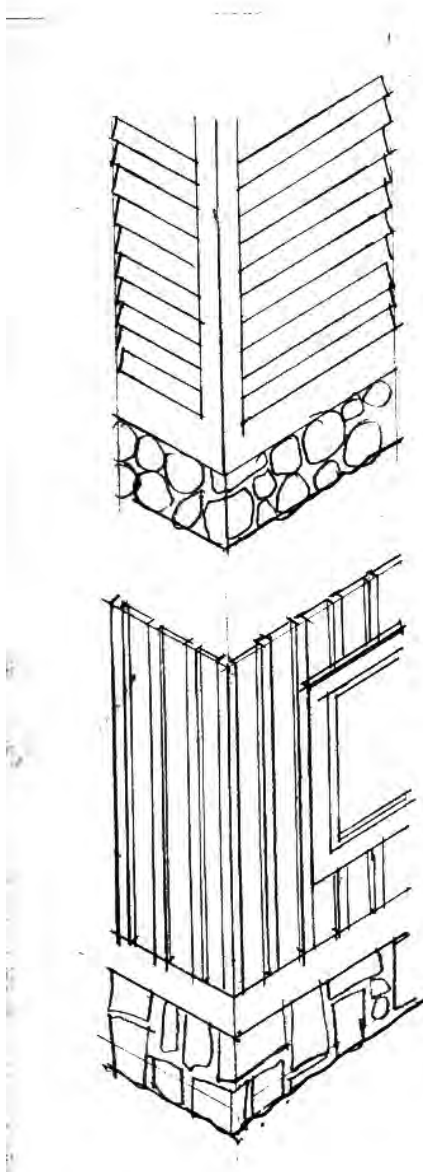

9.2.10 Wood Siding

The most typical historic wood siding types were clapboard and board and batten. Clapboard was commonly installed with about 4 inches to the weather.

Board and batten siding was typically about a 10 inch board with a 2 inch batten.

Note the wide skirt board at the bottom of the walls, and the corner boards on the clapboard.

Stone foundations were common in 19th century buildings. The top sketch shows split-faced fieldstone, and the bottom sketch shows dressed fieldstone

9.2.11 Fencing

Traditional front-yard fencing is usually fairly low. Historic photographs show several fence types in old Thornhill, including wire fencing, horizontal boards and most commonly, wood picket fences. It is a strange fact that old photographs show more picket fences on the Markham side of the village, and this distinction remains true.

There is, and was, considerable variety in design. Narrow boards and wide boards; square, pointed, and rounded tops; and railing-type fences with the pickets housed in the top and bottom rails are all in evidence.

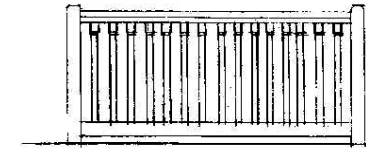
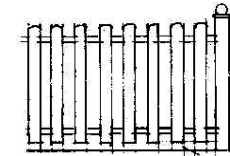
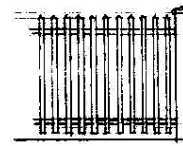
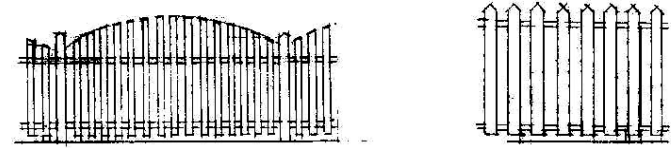

7636 Yonge Street. A neat picket fence with very big gateposts.
MM-Weaver #391, taken in 1906.

9.3 Existing Heritage Buildings

9.3.1 Overview

Thornhill is fortunate in having numerous historic buildings, most of which are structurally sound, with original architectural details still largely intact. In many cases, details are in need of maintenance or repair, or have been obscured or removed by previous renovations. This section aims to assist in the preservation of historic architecture, and the restoration of lost or concealed heritage character, through design that follows the original or is at least sympathetic to it, when new work is undertaken.

Guidelines:

- The existing heritage structures are the most significant elements of the heritage character of Thornhill.
- Buildings that are listed in the Vaughan Register of Property of Cultural Heritage Value are considered to be heritage properties for the purposes of this Plan. The properties listed as of this date are shown in the map to the left. Additional properties that may be included on this Register in the future, will then be considered heritage properties for the purpose of this Plan.
- Proper maintenance of heritage structures prevents deterioration, and is the most cost-effective means of preserving heritage character.
- When heritage features are damaged or deteriorated, repair and restoration are preferable to replacement.
- New construction should not damage or conceal heritage features.
- New construction should include restoration of heritage features that have been lost or concealed by previous renovations.

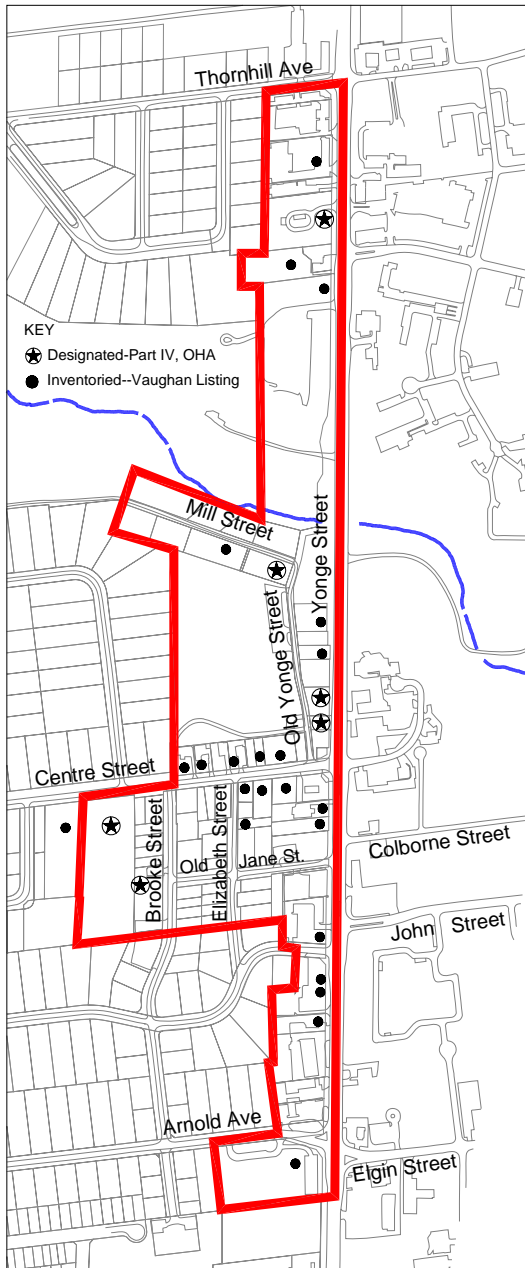

9.3 Existing Heritage Buildings

9.3.2 Historical and Technical Research

The original state of existing heritage buildings should be researched before work is undertaken. On-site investigation often reveals original details concealed under later work. The Vaughan Archives and the Society for the Preservation of Historic Thornhill have extensive collections of historic photographs.

Maintenance, repair, replacement and restoration work should be undertaken using proper heritage methods. Modern materials and methods of construction can have detrimental effects on old construction if proper methods are not used. This is particularly true of old brick. Section 10 lists some books containing relevant technical information.

The United States National Parks Service publishes *Preservation Briefs*, with detailed 'how-to' information on many aspects of heritage preservation and restoration. All 42 of these publications can be downloaded from: www.cr.nps.gov/hps/tps/briefs/presbhom.htm

The Parks Canada Standards and Guidelines for the Conservation of Historic Places in Canada is similar, and is available on line at: www.pc.gc.ca

The Ontario Ministry of Culture also has 13 *Architectural Conservation Notes* at: www.culture.gov.on.ca

9.3.3 Recording Original Construction

It is important to build up the record of historic construction in the District. No reconstruction or removal of historic architectural detail should be undertaken without recording the original with drawings and/or photographs. Copies of these records should be given to Cultural Services at the City of Vaughan. Building such an archive of information is an important community effort.

9.3 Existing Heritage Buildings

9.3.4 Building Maintenance

The principal enemies of existing heritage buildings are fire and water. Proper maintenance is the best way to prevent damage and deterioration from these causes. **The loss of heritage detail and even entire buildings, due to simple neglect, is an avoidable tragedy.**



Standard fire-prevention practices should be followed: check electrical systems, and don't overload circuits; ensure that heating systems are in good condition; and store combustibles properly.

Roofing, flashing, and rainwater drainage should be maintained in good condition. It is far better and cheaper to keep moisture out of the building, than to deal with the damage later.

Structural damage that admits moisture, such as settlement cracks, should be promptly repaired.

Painted woodwork should be maintained.

9.3.4.1 Masonry Cleaning

Masonry cleaning should be done in a non-destructive manner. Ontario bricks are soft and subject to deterioration by harsh cleaning methods. Good results can usually be obtained with detergents and water and a stiff natural-bristle brush. Some professional water-borne chemical agents are acceptable. Sand-blasting and high-pressure water blasting are unacceptable.

Historical photographs show that most original masonry in Thornhill was unpainted. Unless paint can be historically documented it should not be applied, and existing paint should be removed. Paint may be applied only where deterioration of the masonry leaves no other choice. Paint must be vapour-permeable (breathing-type) to prevent deterioration. See illustration at right.

Preservation Briefs has full information on proper materials and methods. See Section 9.3.2 for website.

Guidelines:

- Clean masonry using detergents and a stiff natural bristle brush. If this doesn't produce satisfactory cleaning, use only professional water-borne chemical agents for further cleaning.
- Do not use sand-blasting or high pressure-water for masonry cleaning.
- Do not paint historic masonry unless deterioration of masonry leaves no other choice.
- If masonry must be painted, use an appropriate breathing-type paint.
- Do not cover historic masonry with other materials such as stucco, or siding.



Non-breathing paint on brick. The vapour pressure of moisture in the brick blisters the paint, when it is able. If the paint adheres strongly, the pressure causes the brick surface to spall off, along with the paint, as seen in the centre of the picture. This lets in even more moisture, and the problem grows.

9.3 Existing Heritage Buildings

9.3.4.2 Masonry Repointing

Historic lime mortars weather back from the wall face over time, particularly when they are subject to moisture. This is normal, and repointing is only necessary when the mortar is deeply eroded. Repointing should only be undertaken in areas where the mortar has deteriorated. Don't remove sound mortar unnecessarily, but do poke and prod to make sure the mortar you are keeping is sound. If the pointing mortar is correctly formulated, and the joint is tooled to match the original, the repointing will not present a "patchy" appearance.

Historic lime mortar is softer and more water-permeable than modern portland cement mortars, and it preserves the brick by absorbing movements and providing a path for water to leave the wall. Modern Portland cement mortars, are designed for modern hard-fired bricks, and are highly destructive to softer historic bricks. The colour of historic mortars comes primarily from the colour of the sand in the mix, so care is required to establish a matching appearance.

Guidelines:

- Repair structural damage before repointing. Structural cracks may be letting in the moisture that is eroding the mortar.
- Do not use power tools to remove old mortar. They can damage the weather-resistant skin of the brick and cause future deterioration of the wall.
- Use lime mortar for repairs and repointing of historic brick. Match the original in formulation, with a cement content no greater than one-twelfth of the dry volume of the mix; the cement must be white portland cement and not grey.
- Do not treat historic brick with silicones or consolidants. They trap water vapour behind the surface of the brick which may damage the face by freezing or leaching of salts.



Progressive deterioration: Rainwater splashing on the porch and steps eroded the mortar. That let increasing amounts of water into the bricks and mortar below, and they are spalling and washing away, letting in even more moisture.

9.3 Existing Heritage Buildings

9.3.4.3 Painting Woodwork



Properly maintained and protected woodwork is a very durable building material. Deterioration of wood is almost always due to moisture problems: either a failure of the paint film or a problem, such as a flashing or roofing failure, that allows moisture to infiltrate from above and behind the finish surface. Blistering or peeling paint is usually a sign of moisture penetration. The source of the moisture should be identified and corrected before repainting. Refer to Section 9.3.5.5, below, if repairs are necessary before repainting.

Normally, it isn't necessary to remove sound, well-bonded paint before repainting. Paint removal, when required, is best done using gentle traditional methods. Chemical strippers can impregnate wood and harm the bonding ability of new paint, and excessive heat can cause scorching damage.

Guidelines:

- Inspect existing paint. Blisters or peeling paint usually mean water is getting into the wood, and the source of water should be corrected.
- Don't "strip" woodwork, unless paint build-up is excessive and obscures architectural detail. Just remove loose paint and feather edges.
- Don't use chemical strippers or torches to remove paint. These damage the wood and cause future problems.
- Use suitable heritage paint colours. Original paint colours can usually be found by sanding or scraping through overpainted layers. Otherwise, approved heritage palettes are available at Cultural Services.
- Both *Preservation Briefs* and *Architectural Conservation Notes* have information on painting. See Section 9.3.2. for websites.



9.3.5 Repair and Restoration

Repair and restoration should be based on proper heritage research, and be undertaken using proper heritage materials and methods. Section 10 lists helpful sources of information.

9.3.5.1 Brickwork

Brick repair should be undertaken using proper heritage materials and methods. If available, salvaged bricks matching the original should be used for replacement material. If new bricks are necessary, they should match the original in size, colour, and finish. The traditional Ontario brick size is still manufactured, but in small quantities, so material may have to be ordered well in advance of the work.

Historic bricks require the use of historic lime mortar. See the notes and guidelines in Section 9.3.4.2, under masonry repointing.

Guidelines:

- Repair structural damage before restoration.
- Use matching bricks for repairs, either salvaged old material or the best modern match in size and colour.

9.3.5.2 Stonework

Spalled stone can be restored using professional epoxy-based fillers matching the underlying stone. More serious deterioration will require replacement by new material, matching the existing. Use of precast concrete to replace stone is discouraged.

9.3 Existing Heritage Buildings

9.3.5.3 Roofing

Heritage buildings might have originally had wood shingles, slate, or sheet metal roofing. Very few of the original roofs remain, and the asphalt shingle is the dominant roofing material in Thornhill today. In re-roofing heritage buildings, care should be taken to choose a material that relates to the original roofing. If asphalt shingles are selected, colours should be black or a dark grey, like slate or weathered cedar. The use of textured premium grades improves the simulation, and synthetic slates and panelized synthetic cedar shingles can present a very realistic appearance. Note that roofing tiles are not part of the local vernacular, and tile or simulated tile (of concrete or pressed steel) are not appropriate.

9.3.5.4 Wood Frame Construction

The earliest buildings were of log construction but were quickly supplanted by wood frame construction. Over history, original siding materials would have included wood clapboard, board and batten, and more rarely, stucco. Agricultural buildings used vertical boards. The heritage quality of many old buildings has suffered by the application of aluminum or other modern sidings. Renovations to wood frame heritage construction should include restoration of original siding materials when they have been covered by these inappropriate materials.

9.3.5.5 Decorative Woodwork

Deteriorated woodwork should be repaired, if possible, rather than replaced. Repairs should use the same wood species and design as the original. If replacement is necessary, it should conform to the original design, and wood should normally be used, rather than modern materials. Well-maintained and properly detailed woodwork is quite durable: much of the existing heritage decoration in Thornhill has lasted more than a century. In certain situations, with extreme exposure to weathering, modern materials may be acceptable.



With occasional maintenance, the wood “gingerbread” trim and windows have lasted about 150 years.

9.3.5.6 Heritage, Energy, and Sustainable Design

There is a great deal of concern today about sustainable design and energy conservation. Heritage buildings date from a time when these were not issues in the way that they are today, and technologies such as furnaces, insulation and double-glazing had not yet been invented.

However, the need for comfort existed in earlier times, and heritage buildings employed a variety of strategies to create liveable buildings in the days before central heating.

Compared to modern buildings, heritage buildings have a relatively small percentage of window openings. Even an ordinary wall has a much better thermal performance than the best glazing. Heat loss in winter and solar gain in summer are reduced simply by having smaller window areas. Historic windows were all openable, and natural ventilation in hot and moderate weather provided comfort without energy expense.

Planting was another comfort strategy: coniferous trees provide a break against northwest winter winds, and deciduous trees provide shading of southwest summer sun.

Solid masonry buildings make use of thermal lag, which means they transfer energy slowly. For instance, in summer the walls cool at night, and it takes a long time for the heat of the day to re-warm the walls to the point that they are adding heat to the interior. This effect provides comfort above what would be expected from a simple R-value calculation.

In general, heritage buildings have many features that work for energy conservation.

Retrofitting:

Nonetheless, most owners want improved thermal efficiency in their heritage buildings, due to rising energy costs and modern comfort standards.

It is important to consider the energy performance of the whole building in developing a strategy for energy-saving retrofits. Heat losses in heritage houses usually occur, in descending order:

- through the roof or attic,
- through air infiltration—door and window edges, and construction joints.
- through basement walls and crawl spaces,
- through walls and windows.

An efficient retrofitting program should address these areas in the same order:

- insulate the roof,
- caulk and weatherstrip,
- insulate basement walls and crawl spaces,
- insulate walls, install storm windows or replacement windows.

It is prudent to have a professional energy audit to verify the sources of energy loss in the building, and to obtain professional heritage advice on energy-saving techniques that are not detrimental to the heritage building.

9.3.5.6 Heritage, Energy, and Sustainable Design, Cont'd

Windows

Historic wood windows perform very well in terms of life-cycle costing, and can have very good energy efficiency as well. It is worth considering these factors before deciding to replace original windows. Many historic windows have lasted for more than a century, with only minor routine maintenance, such as puttying, painting, and the occasional adjustment of fit and hardware. It is unlikely that any modern replacements would venture to guarantee similar longevity.

In addition, the overall energy performance of a window assembly is more dependent on air leakage than on the insulative qualities of the glass itself. It is fairly easy and inexpensive to improve the fit and add weatherstripping to historic windows, so that air infiltration matches modern standards. The addition of interior or exterior storm windows gives further energy savings, and eliminates or reduces the biggest problem of single glazing, which is cold-weather condensation.

A recent speech by Donovan D. Rypkema, the foremost expert in the economics of preservation, noted that:

Properly repaired historic windows have an R factor nearly indistinguishable from new, so-called “weatherized” windows.

Regardless of the manufacturers’ “lifetime warranties,” 30 percent of the windows being replaced each year are less than 10 years old.

One Indiana study showed that the payback period through energy savings by replacing historic wood windows is 400 years.¹

Original window frames and sashes should be repaired if possible, rather than replaced. Repairs should be limited to damaged portions of the window assembly. This is not only good heritage practice: it is usually less costly. Repair material should be of the same species and profile as the originals.

More information is available online from Preservation Briefs: No. 3—Conserving Energy in Historic Buildings, and No.24—Heating, Ventilating, and Cooling Historic Buildings. See Section 9.3.2 for the website.



Life-cycle costing makes wood look good. The District has many wood windows that are still in service after more than a century.

“No maintenance” materials can’t be maintained, and need replacement when they fade, chip and dent.

¹ Speech to the Annual Conference of the National Trust for Historic Preservation. Portland, Oregon, October 1, 2005.

9.3.5.6 Windows

Replacement Windows

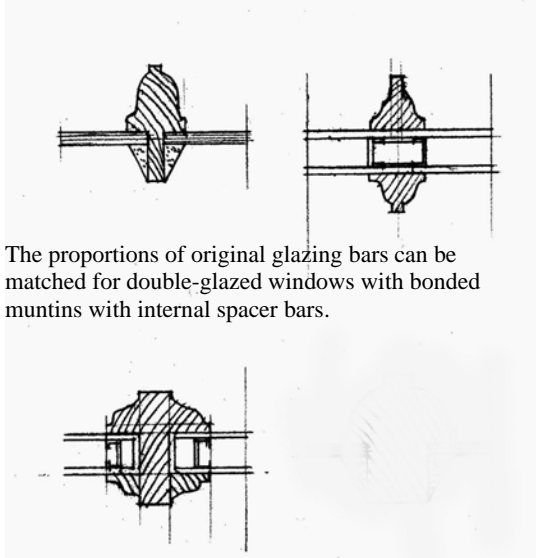

The proportions of original glazing bars can be matched for double-glazed windows with bonded muntins with internal spacer bars.

Most double glazed “true” lights require glazing bars that are much wider than the originals.

If original windows cannot be repaired or restored, replacement windows are an option. If possible, replace only damaged portions; for example, replace the sash but retain the frame. Window design should match the original in type, glazing pattern, and detail. In many buildings, windows have been replaced, and it may require some research to determine the original design. The descriptions in Section 9.2.4 may be useful, or original windows in similar neighbouring buildings might offer a clue.

In recent years window manufacturers have responded to the market for authentic heritage windows. Catalogues now include round and segmental arch heads and a variety of glazing patterns, providing good representations of most historic styles.

Some care needs to be taken in detailing. Two common problems are heavy glazing bars, and horizontal orientation of the panes in multi-light sash.

True muntins for double-glazed windows are too heavy to preserve the proportions of original windows. Bonded muntins inside and out, with spacer bars in the air space, provide better proportions for an authentic appearance in most residential-scale windows.

Care is also needed in the proportions of the “panes”, which should have a greater height than width. Depending on the manufacturer, and the size and type of window, the manufactured muntin grilles may not have correct proportions.

“Snap-in” interior muntins or tape simulations are not acceptable.

9.3.6 Renovations

When a renovation on a heritage building is undertaken later work that conceals the original design or is unsympathetic to the building should be removed.

Guidelines:

Incorporate restoration of original work in exterior renovation projects.

- Use authentic original materials and methods. For example, when replacing aluminum siding, use wood siding or board and batten. See materials checklist in Section 9.8.
- Replace missing or broken elements, such as gingerbread, spindles, or door and window trims.
- Remove items, such as metal fascia and soffits that conceal original architectural detail.

9.3 Existing Heritage Buildings

9.3.7 New Additions to Heritage Buildings Architectural Style

New attached additions to heritage buildings should be designed to complement the design of the original building.

Guidelines:

- Design additions to maintain the original architectural style of the building. See Section 9.1.
- Use authentic detail. See Section 9.2.
- Research the architectural style of the original building. See Section 10 for useful research sources.
- Follow the relevant guidelines for new construction in Section 9.5.



These additions follow the Georgian precedent of the original building.

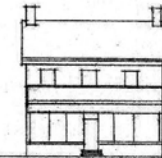
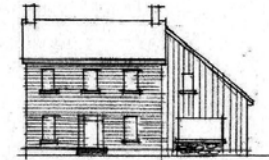
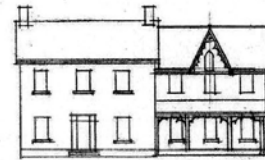

These additions use styles that don't match the original.

9.3 Existing Heritage Buildings

9.3.7 New Additions to Heritage Buildings

Scale

New additions to heritage buildings should respect the scale of the original building.

Guidelines:

- Don't design additions to a greater height or scale than the original building.
- Don't design additions to predominate over the original building.

Usually, additions should be located at the rear of the original building or, if located to the side, be set back from the street frontage of the original building.

- For garage additions, see Section 9.3.8
- Use appropriate materials. See Section 9.8.
- Avoid destruction of existing mature trees. See Section 9.7.

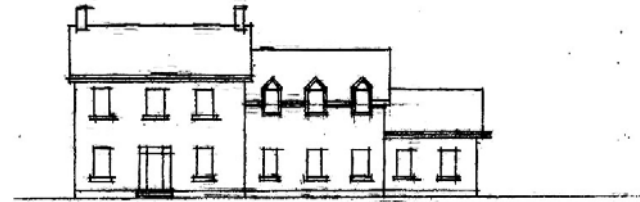
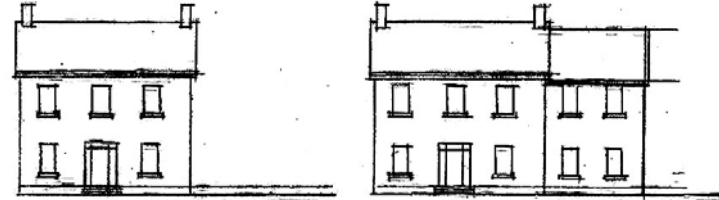

In keeping with good heritage practice, these additions are of lesser scale than the original house and are set back from the main front wall.

9.3 Existing Heritage Buildings

9.3.8 Outbuildings for Heritage Buildings.

Traditionally, garages or stables were built as separate rear outbuildings with gable roofs.

Guidelines:

- Work on existing heritage outbuildings should retain or restore original design features.
- New garages should respect traditional siting as separate rear outbuildings, wherever possible.
- Connected garages should minimize their street presence. For example, a garage may be turned so that the doors face a side lot line, or it may be set well back from the main frontage, with the connection to the main building disguised or hidden.
- Design garages to traditional outbuilding forms, with gable roofs, and frame or brick construction.
- Use single-bay garage doors, compatible with traditional designs. Suitably designed overhead doors are now widely available.
- Other outbuildings, such as garden and storage sheds, should be of traditional wood construction when visible from the street. Prefabricated metal sheds, if used, should be located to be out of view from the street.

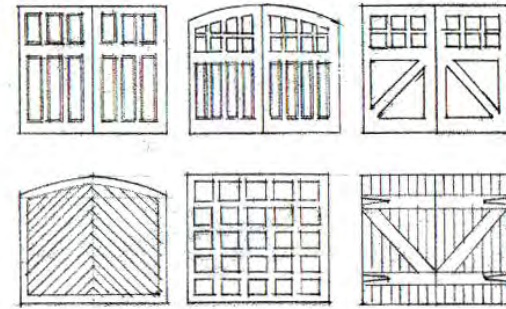

Garages should be designed with single bays, and doors should reflect historic designs. There are now a wide range of heritage-compatible doors available from many manufacturers.

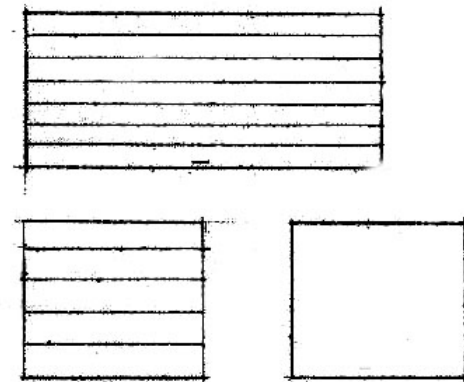

Double-bay garage doors and flat slab-type garage doors are not appropriate in the District

9.4 Existing Non-Heritage Buildings

Most of the buildings in the Village are not considered heritage structures. Many of these, by virtue of their scale, siting, and surrounding landscaping, nevertheless contribute the overall character of the area. Buildings deserve some respect on their own terms, and it is not the intent of the Guidelines to ask newer buildings to pretend to be anything other than what they are.

A typical 1970s ranch bungalow.

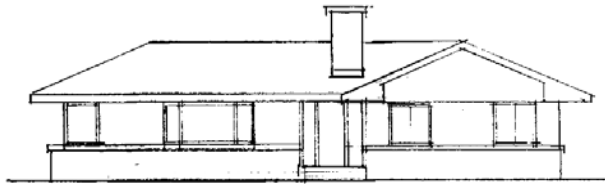

9.4.1 Design Approaches

Additions and alterations to non-heritage buildings have an impact on their heritage neighbours and the overall streetscape. There are two design approaches that are appropriate to additions and alterations to such work in the Village.

9.4.1.1 Contemporary Alteration Approach

Ordinarily, a modern building should be altered in a way that respects and complements its original design. Interest in preservation of the modern architectural heritage is growing, and good modern design deserves the same respect as good design of the 19th century.

Guidelines:

- Additions and alterations using the Contemporary Alteration approach should respect, and be consistent with, the original design of the building.
- The Guidelines in Section 9.3.6 for additions to heritage buildings apply, in terms of siting, scale and location of additions.
- Many modern buildings are old enough to have already undergone renovations, which may not be in character with either the original design, or historic precedent. In such cases, the design of further new work should restore the architectural consistency of the whole.
- In some cases, modern buildings predominantly feature materials that are out of keeping with the local vernacular heritage, such as tile or artificial stone veneer, and tile or simulated tile roofing. Replacement of these materials with more sympathetic ones, when renovations are being undertaken, is encouraged.

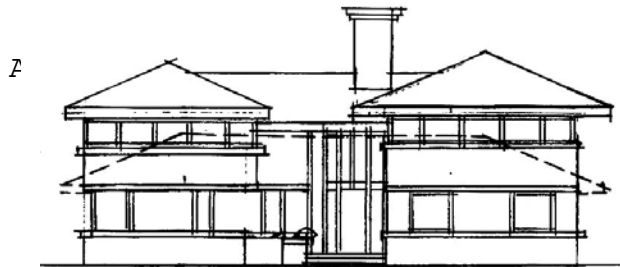

The Contemporary Alteration approach used in putting on a second storey addition.

9.4 Existing Non-Heritage Buildings

9.4.1.2 Historical Conversion Approach

In some cases, a modern building may be altered in a way that gives it the appearance of an older building. A historical conversion should have the integrity of an historical architectural style. This approach means considerably more than sticking on a few pieces of historical decoration; it may require considerable new construction to achieve an appropriate appearance.



The Historical Conversion approach used in putting a second storey addition on the same 1970s ranch house.

Guidelines:

- Additions and alterations using the Historical Conversion approach should rely on a local heritage style described and depicted in Section 9.1. Use of a style should be consistent in materials, scale, detail, and ornament. Refer to new construction guidelines in Section 9.5 for further guidance.
- Although most additions should be modest in comparison to the original building, the Historical Conversion approach may call for substantial additions in front of, and on top of, the existing building.
- Additions should avoid destruction of existing mature trees. See Section 9.7.

9.5 New Development

9.5.1 Overview

The overall heritage character of the District is composed of buildings, streetscapes, landscapes, and vistas. This overall character has more significance than any individual building, even if it is one of the finest. Within the design of any individual building, architectural elements contribute to the character of the public realm of the street. Massing, materials, scale, proportions, rhythm, composition, texture, and siting all contribute to the perception of whether or not a building fits its context. Different settings within the district have different characters of siting, landscaping and streetscaping.

New development within the District should conform to qualities established by neighbouring heritage buildings, and the overall character of the setting. Designs should reflect a suitable local heritage precedent style. Research should be conducted so that the style chosen is executed properly, with suitable proportions, decoration, and detail.

Guidelines:

- New buildings should reflect a suitable local heritage style. Use of a style should be consistent in materials, scale, detail, and ornament.
- Use Section 9.1 for preliminary guidance on styles.
- Use Section 9.2 for further preliminary guidance on details of design and construction.
- It is strongly recommended that owners engage design professionals skilled in heritage work for new buildings in the District.

9.5 New Development

9.5.2 Residential Area Overview



The residential village has a variety of lot sizes, frontages, and setbacks. Houses are mostly of a modest scale, leaving fairly generous yards on all sides. In the historic area front yards tend to be shallow compared to the rear yards, where space was needed for stabling, herb and vegetable gardens, and orchards. The use of the yards has changed, but the original village scale has persisted. Building height, lot coverage, and density are all low. The streetscapes are unified by a canopy of trees, planted in front of, behind, and beside most houses. Elements that define the heritage character of the residential village include:

- Generous lot sizes and modest house sizes, compared to historic urban development or recent suburban development;
- A variety of front-yard setbacks;
- The generous presence of mature trees, in addition to decorative shrubbery, in the front, side, and rear yards.
- For purposes of this Plan, the Centre Street houses that have been converted to commercial uses are considered part of the residential village. Refer to Section 9.5.2.4 for special guidelines for these properties.

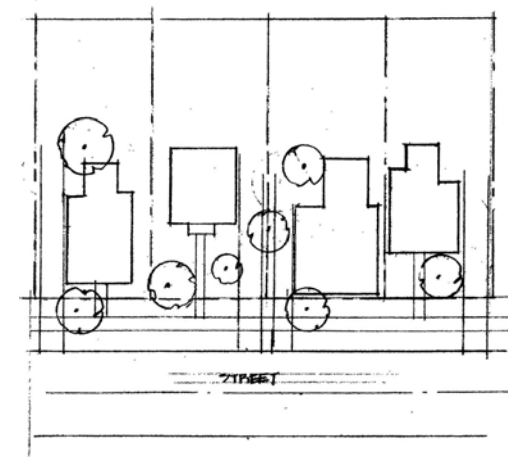

Buildings and trees share in forming the streetscape.

9.5 New Development

9.5.2.1 Site Planning

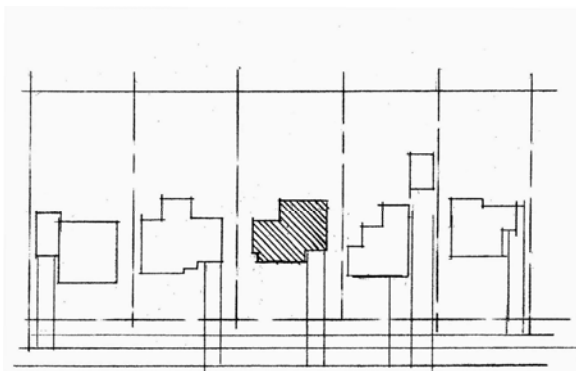

Respect the existing site plan character of similar, but not identical front-yard setbacks.
Place a new building to mediate between setbacks of neighbouring buildings.

Guidelines:

- Site new houses to provide setbacks and frontages that are consistent with the variety of the village pattern.
- Site new houses to preserve existing mature trees. See Section 9.7.

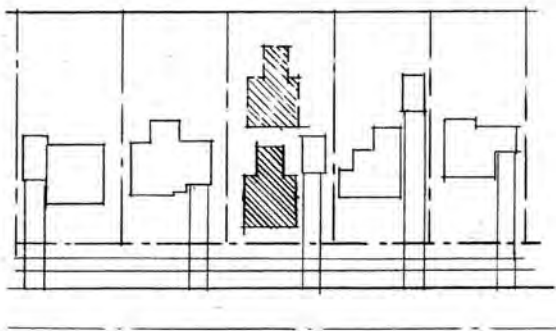

An extreme difference in setback from adjacent buildings is not appropriate.

9.5.2.2 Architectural Style

New buildings in the residential areas should reflect the historic built form of their historic neighbours.

Guidelines:

- Design houses to reflect one of the local heritage Architectural Styles. See Section 9.1.
- Hybrid designs that mix elements from different historical styles are not appropriate. Historical styles that are not indigenous to the area, such as Tudor or French Manor, are not appropriate.
- Use authentic detail, consistent with the Architectural Style. See Section 9.2.1.
- Research the chosen Architectural Style. See Section 10 for useful research sources.
- Use appropriate materials. See Section 9.8.



It's possible to build new houses that are highly compatible with heritage buildings. These recent houses were built in the Unionville Heritage Conservation District.



9.5.2.3 Scale and Massing

New residential construction in the residential villages should respect local heritage precedents in scale and massing. In almost every case, new construction will be replacement houses on existing built lots. Note: It is recommended in Section 7.3 that the zoning by-law be amended to recognize the smaller scale of historic village development as contrasted with modern suburban development.



Design new houses to be consistent with the scale of neighbouring ones.



Don't design new houses that are inconsistent with the existing neighbourhood scale.

Guidelines:

- New buildings should be designed to preserve the scale and pattern of the historic District.
- New houses should be no higher than the highest building on the same block, and no lower than the lowest building on the same block.
- As far as possible, modern requirements for larger houses should be accommodated without great increases in building frontage. For example, an existing 1½-storey house could be replaced by a 2-storey house with a plan that included an extension to the rear. This might double the floor area without affecting the scale of the streetscape.
- Follow the policies in Section 4.2 of this Plan concerning height and depth of buildings and garages.
- For garages, see Section 9.3.8.

9.5.2.4 Commercial Aspects

Conversion of houses in the residential area to commercial uses, as has occurred on Centre Street, introduces two new requirements: signage and parking. It is important, in maintaining the heritage character of the District, to minimize the visual impact of these aspects when viewed from the public realm.

Guidelines:

- The house form and architectural details of converted residences should be preserved, and signage is not to be mounted on the buildings. Ground signs, in conformity with the Sign By-law, are appropriate.
- Paved areas toward the front of lots should be minimized. Parking areas in front yards are not appropriate. In order to minimize the paved areas and number of traffic entrances, the consolidation of parking areas, with shared entrances is supported.

9.5.3 Yonge Street Commercial Areas

The guidelines in this section reflect the vision for Yonge Street as depicted in the *Thornhill Yonge Street Study, 2005 – A Framework for Renewal, Reinvestment and Community Building* that was endorsed by Council in April 2006. The *Thornhill Yonge Street Study* provided the basis for the policies and designations of *Official Plan Amendment (OPA) 669* to the *Thornhill-Vaughan Community Plan OPA 210-1997*.

In Vaughan, the *Thornhill Yonge Street Study, 2005* and *Official Plan Amendment 669* apply to the southern part of the Heritage Conservation District, extending from the Thornhill Public School to just north of Centre Street. This area is indicated with hatching at the southern end of the map to the right, and is referred to in *OPA 669* as “The Thornhill Yonge Street Corridor”.

Within the time horizon of this plan, there is also re-development potential for the commercial lands at the northern end of the Heritage Conservation District. This area is indicated with hatching at the northern end of the map.

In order to maintain a consistent approach to redevelopment in the District, the Design Guidelines in Section 9.5.3 and the Streetscape Guidelines in Section 9.6.3 will apply to all Yonge Street commercial developments in the Thornhill Vaughan Heritage Conservation District. It is recommended that Official Plan provisions, consistent with those in *OPA 669*, be considered for the northern commercial area.

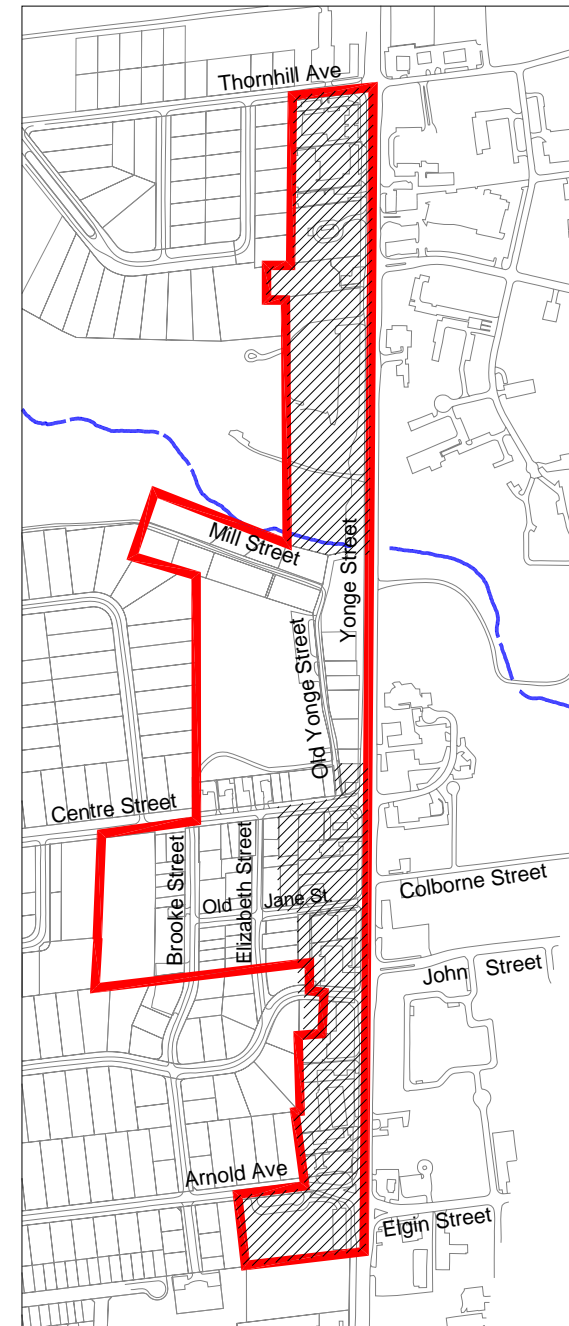

9.5.3.1 OPA 669: Objectives and Vision

The Thornhill/Yonge Street Corridor Area is intended to become a vibrant, mixed use area. It is to be developed as a higher order transit corridor. Intensification and redevelopment will be promoted at key locations within the corridor in order to bring vitality to the area. The intent is to promote residential, commercial and employment growth, support transit use and enhance the urban design quality of the corridor through redevelopment. Redevelopment opportunities will also be used to repair existing gaps in the street wall and provide for rear yard parking.

At the same time, the Thornhill Yonge Street Corridor Area overlaps part of the Thornhill Heritage Conservation District, and while intensification opportunities exist within the Heritage Conservation District, proposals must be very carefully conceived to ensure that the resulting development is compatible with and enhances the heritage character of the area.

In order to reinforce the unity of the Heritage Conservation District, these guidelines in section 9.5.3 of this Plan apply to all Yonge Street commercial sites within the District, including those north of the Thornhill Yonge Street Corridor.

The vision for the Thornhill Yonge Street Corridor Area is characterized by:

- a) a vibrant and mixed use main street;
- b) a predominance of at grade commercial/retail uses along Yonge Street;
- c) an attractive, high quality, pedestrian friendly, transit supportive streetscape;
- d) differing scales of development including transit supportive mid rise intensification and smaller scale infill projects to complement existing heritage assets and adjacent residential neighbourhoods;
- e) protection for, and enhancement of heritage resources and their environs;
- f) new public parks and plazas and enhanced connections to the surrounding open space system; and,
- g) organized access and parking to the rear of commercial and mixed use properties.

In addition to the guidelines in this document (which are based on the *Thornhill Yonge Street Study, 2005*), all new development within this commercial area is subject to the general land use policies and urban design policies for the Thornhill/Yonge Street Corridor Plan Area as developed in *Official Plan Amendment 669*, and is to be consistent with the provisions of the *Thornhill Yonge Street Study, 2005*.

9.5.3.2 Built Form Vision

The objective of the proposed built form for the Yonge Street commercial corridor is to enable the development and insertion of more intense forms of development within the context of existing heritage and complementary buildings. *The Thornhill Yonge Street Study, 2005* describes the basic building form:

- Building massing should reflect a linked series of pavilion type buildings defined by recessed connector building segments. This variety in setback will create certain buildings that have greater emphasis and is somewhat in keeping with the character of a village which would have had independent buildings with sideyards.
- Mid-block pavilion building segments should generally occupy 15-20 metres of the street frontage whereas corner pavilion segments should occupy more frontage (25 -30 metres)
- The recessed connector building segments should generally occupy 6-15 metres of street frontage, and should be set back from the mandatory streetscape setback an additional 1.5 to 3.0 metres. This additional setback will provide an area of refuge for private landscape enhancements as well as street furniture.
- Long, homogenous facades are to be avoided.
- Pedestrian “through building” connections from Yonge Street to rear commercial parking areas are desirable especially for any development exceeding 50 metres of continuous building frontage.
- Massing and built form should step down to respond to and respect adjacent heritage buildings.

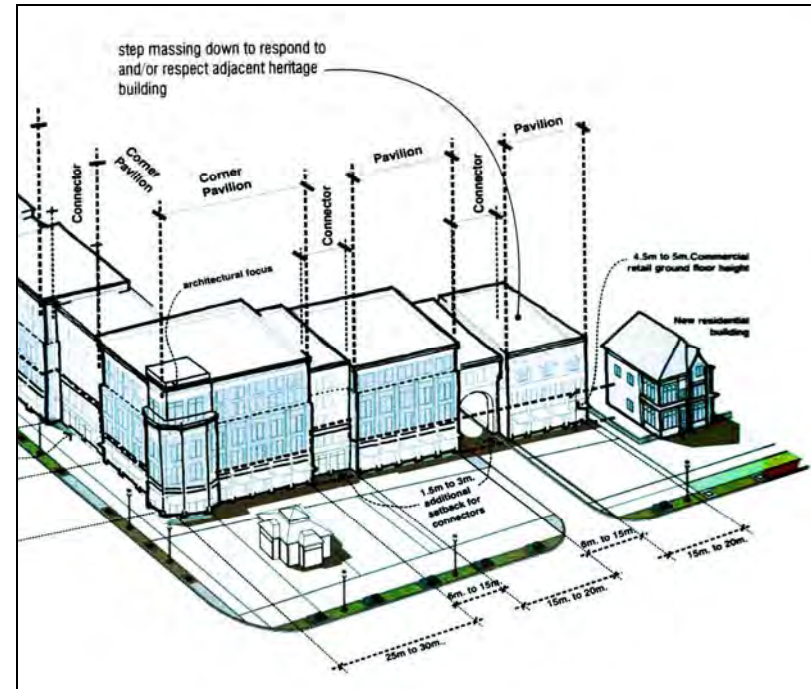

Conceptual illustration of the Pavillion and Connector massing concept and step-downs adjacent to heritage and residential properties. From the *Thornhill Yonge Street Study, 2005*.

9.5.3.3 Location and Setbacks

New buildings should be set back to create an enhanced public streetscape realm. When new development is proposed adjacent to heritage buildings, special care must be taken to ensure that the views to the heritage resource are protected.

Guidelines

1. Buildings should be sited to address: 1) corner or intersection locations, 2) the primary street frontage, and 3) street frontage on the secondary/local street.
2. Buildings should be oriented towards public streets to clearly define the public realm, create a consistent street wall and create an attractive retail and commercial environment for pedestrians.
3. The segment or component of the new building adjacent to heritage buildings should align with the building face of the heritage building.
4. A side yard setback of 4 to 6 metres should be achieved to emphasize the importance and prominence of the heritage building anchors or pavilions and should allow greater visibility from the road. The side yard may be used for pedestrian or vehicular access to the rear of the property.
5. Buildings fronting on Yonge Street should occupy a minimum of 70% of the frontage along the property line and buildings on secondary or local streets should occupy a minimum of 50% of the frontage along the property line.
6. To achieve an enhanced streetscape, a 1.8 m minimum setback from the edge of the public right of way is required for all properties fronting onto Yonge Street and all secondary streets. This will create a minimum 7 metre public realm from curb edge to building face. The additional 1.8 metre streetscape zone will be implemented by development proponents in a manner consistent with the streetscape improvement program.
7. Setback for development on local streets should be generally consistent with the setbacks of existing development

9.5.3.4 The Character of Historic Commercial Streetscapes

Historic commercial areas can be characterized as village-type or town-type streetscapes. Villages tended to have an informal layout, with a variety of front and side-yard setbacks. Shops were typically gable-roofed buildings, perhaps with display windows on the ground floor, and often a porch. Sometimes there was a 'boom town' false front obscuring the gable. The top photograph shows MacDonal's Store, which is of this type. The store was demolished in 1971.

When a village evolved into a town, the layout became formal, with a continuous line of shopfronts on the street lotline. Display windows tended to be larger and taller, and the flat-roofed commercial building became the prevalent building type, often built as block of several properties contained in a single architectural form. In Thornhill this evolution barely got underway. The Sterling Bank and the Francis Block are the only town-type commercial buildings constructed in Thornhill. These are shown in the lower two photographs, and it can be seen that the other commercial buildings retain the form of village shops, with gable roofs and varied front-yard setbacks.

9.5.3.5 OPA 669: Historical Model

The massing guidelines in the *Thornhill Yonge Street Study, 2005*, (page 65) recognizes both the village and town-type precedents. The basic building form that is envisioned derives from the town-type commercial streetscape. But rather than having a continuous street-line frontage, the masses are broken up into "pavilions" of about 20 metres in width. This frontage is in scale with the frontage of the Francis Block. The pavilions are separated by recessed "connectors" of 6-15 metres in width, which respects the broken street frontage that is typical of village-type commercial streetscapes.

The following pages describe the character of historic commercial buildings and provide design guidelines for heritage-friendly design within the basic envelope of the *Thornhill Yonge Street Study, 2005* and *OPA 669*. Photographs of buildings from many municipalities have been used, in order to make use of the riches of Ontario's commercial heritage resources.



Village Hardware, Detail from MM-Weaver 280, 1965t



Sterling Bank, Yonge at Centre. MM-Weaver #273, 1925.



Francis Block, on the left. MM-Weaver 270, 1907.

9.5.3.6 The Character of Historic Commercial Architecture

Historic town-type commercial buildings, from about 1870 on, share a number of common characteristics.

Following a series of town-razing fires in the mid-19th century, buildings were built of masonry. In some towns, stone was locally available, but in most places, construction was brick.

Shops were typically built in bays about 7.5 metres wide. Interestingly, this module is still used in large shopping malls. Larger stores would occupy two bays, with a line of columns supporting the mid-wall above. This fairly standard building module creates strong pedestrian-scale rhythm in historic shopping districts.

Building facades are divided horizontally in the Classical three-part scheme of base, body, and cap. The base consists of the storefront and signband. The body consists of the upper masonry wall of the building, with its punched windows. The cap consists of a cornice, which is sometimes capped with a sloping roof with dormers.

The building's base is similarly divided into three parts. The bottom portion is the paneling below the glazing. The middle, or body, is the shop display windows. The cap is the signband, with its own cornice and details. Entrances are recessed, and large retractable awnings are commonly installed.

These Classical schemes provide legibility and scale to the building façade, and are another important factor in creating a pedestrian-friendly visual environment.



The three-part divisions of the buildings and the rhythm of the bays produce a comfortable pedestrian scale. The generally consistent shopfront height, and the common use of awnings helps to unify the character of the public realm. This example is from Collingwood's largely intact, and commercially successful, downtown shopping area.

9.5.3.7 Architectural Styles

Traditional commercial areas in Ontario encompass a wide variety of historic architectural styles ranging from Georgian to Edwardian in composition.

Guidelines

1. New mid-rise development should be products of their own time, but should be compatible with the basic tenets and styles of traditional historical commercial architecture typically found in an older Ontario downtown setting.
2. Buildings should be articulated to express a building base with traditional storefronts, a mid section and a top or cornice.
3. A consistent approach to design detail for the chosen style should be used for all building elements.
4. It is important to recognize that the overwhelming characteristic regarding style in Thornhill was its simplicity. Overly elaborate styles and others not generally compatible with a local village context should be avoided.



This photograph of Main Street in Cobourg shows a recent infill building in the foreground, with original 19th-century buildings beyond.

The low-sloped end-gable roof was common from around 1840 to 1860, with the attic floor used as unheated warehouse space for the shop below. Dormers, to provide light in the attic, are visible on the historic buildings to the left of the lamp post.

This style of commercial building, which dates from the same period as Thornhill's earliest surviving houses, is an appropriate model for Yonge Street redevelopment.

9.5.3.8 Heritage-Friendly Design of New Developments

Not All Stepbacks Are Created Equal

The function of façade stepbacks is to create an architecturally legible street wall that encloses the public realm, provides some continuity in buildings of different maximum heights, and contributes to the pedestrian-scale environment.

Step-backs, and their detail design, should be respectful of the horizontal modules created by adjacent and neighbouring buildings, particularly if those buildings are heritage resources.

Guidelines:

- The base of a stepped back building should be architecturally legible; it should read as a building from the pedestrian level.
- Stepbacks should be sufficiently deep that the upper levels don't overwhelm the base when viewed from the pedestrian level.
- The height of the base should usually be 2 or 3 stories high, in keeping with historic patterns.
- Cornice and sill heights should relate to adjacent buildings whenever possible.



These photographs show two recent buildings in Burlington designed with step backs for the upper storeys. “Harbourview” above, has a strong stepback, with a distinct and architecturally legible two-storey podium. Both horizontal and vertical divisions create a pedestrian-friendly scale.



Across the street, the parking garage has two competing bases—one at 1 storey and another, barely set back, at 2 storeys. The lack of clarity in the base actually emphasizes the bulk above.

9.5.3.8 Heritage-Friendly Design of New Developments Cont'd

Rhythm and Frontages

The traditional width of shopfronts, with intervening pilasters, is an important element in establishing a pedestrian-friendly scale. A little visual event occurs every dozen steps. It makes walking comfortable. Shopping mall developers recognize this, and typically establish bay widths of 25 feet (7.62 metres).

The Francis Block is about the size of a town-type commercial block that would have been built in any village of Thornhill's size, 3 or 4 stores in width. Respect for the scale of groups, as well as the scale of individual shop fronts will help establish a Thornhill character that is distinct from larger communities like Toronto or even Aurora.

Guidelines:

- Low rise buildings and the bases of mid-rise buildings should express a traditional bay-width of 6 to 8 metres, using piers or pilasters to form substantial and legible divisions of the facade.
- Larger developments should consider breaking down their widths into elements of 4 bays or less. For example a nine bay building could have a centre portion that is set off with heavier piers, or a change in the design of upper-floor window pattern.



Another recent building in Burlington makes use of traditional rhythm in the spacing of the brick piers. The rhythm is emphasized by the awnings, which also respect the height of the shopfronts in the historic buildings beyond.

9.5.3.8 Heritage-Friendly Design of New Developments Cont'd

Base, Body, and Cap

The traditional division of building elevations and masses into base, body, and cap helps articulate a human scale, and gives the building a distinct and legible form. The base relates directly to the pedestrian scale. The body should reflect the human scale in its detailing. And the cap establishes the skyline of the street wall that encloses the public realm.

Guidelines for the Base:

- The base of street façades should be well defined, with a strong horizontal cap element to reinforce its pedestrian scale.
- The base should incorporate large glazed areas for transparency, to animate the public realm with displays and interior activity. See guidelines for storefronts and signage on the next page.
- The base should have high-quality detail and material.
- The height of the base should be complementary to the bases of neighbouring buildings, where possible. The height of the base should be between 4.5 and 5.5 metres (14'-9" and 18')

Note:

The *Thornhill Yonge Street Study, 2005* suggests a ground floor height of 4.5 to 5 metres (14'-9" to 16'-5"). This may be too high for smaller shops, and allowing for structure and ductwork might result in a second floor elevation that is excessive. The visual height of the base is more significant than the ceiling height behind it in establishing a traditional streetscape with consistent and pedestrian scale, so this guideline refers to the base rather than to the ground floor height.



Historic commercial design, this example from Collingwood: The shopfront forms the base, the wall forms the body, and a wide fascia and cornice forms the cap.



This recent Port Credit development on Lakeshore Road follows the traditional three-part design scheme, and would not be out of place next to the Collingwood buildings.

9.5.3.8 Heritage-Friendly Design of New Developments Cont'd

Shopfronts and Signage

Like the building, historic shopfronts have a base, body, and cap. The overall effect is to create a frame for the display window area. Traditionally, the base consisted of wood panels about 0.5 to 0.8 metres high, and the cap consisted of a substantially projecting cornice above a sign band that was 0.5 metres high, or less. Often, substantial decorative terminal blocks punctuated the signband and cornice at the building bays. Sometimes signs were painted on the inside of the glass. Shop windows were framed with wood, often decorated with fluting or turnings. Entrances were recessed, often with a shallow angle in the side glazing. In the days before air-conditioning and tinted glass, awnings were a prominent feature in retail streetscapes. With some adaptation, the basic scheme of traditional storefronts can accommodate a variety of modern retail design.

Guidelines:

- The use of highly traditional shopfront designs is encouraged as an option.
- High-quality modern shopfront materials and designs, such as frameless glass, are acceptable alternatives.
- Shopfront designs should provide the framing elements of bays, base, glazed body, and signband with cornice.
- Signbands should be no more than 0.7 metres high, with signage of individual letters, front lit, or individually backlit. Signs must conform with the municipal Sign By-Law.
- Sign band cornices should be substantial in order to establish a legible cap for the building base.
- To animate the street, shop windows should retain their transparency, and not be obscured by excessive postering or window signage. Night-time window shopping is an important animating activity.
- Entrances should be recessed.
- Use of retractable awnings is strongly encouraged. Traditional awnings are the simplest and cheapest way to unify a commercial streetscape. Fixed awnings and awning signs are not appropriate.



Two shopfronts that were once identical. The one on the right has kept the original turned wood corner posts, but has covered the upper elements with an unsympathetic sign box. The cafe on the left has installed frameless glass, but uses traditional individual letters, and the top lighting bar acting as a cap to the composition—a better solution.



A modern storefront that preserves the cornice and awning. The horizontal glazing bars reflect the transoms that were part of historic shopfront design.

9.5 New Development

9.5.3.8 Heritage-Friendly Design of New Developments Cont'd

Base, Body, and Cap

Guidelines for the Body:

- The body of the street façade should be of smooth brick, with punched windows, i.e., distinct and separate openings in the wall, rather than modern curtain wall.
- Windows openings and design should respect traditional proportions.
- Windows should not be coloured or mirrored.
- Detailing such as string courses, decorative inserts, special shaped bricks, arch lintels, and stone lintels and sills help break down the scale of the body and animate the façade. They are encouraged.
- Pilasters that continue the division of bays at the base are encouraged.

Guidelines for the Cap:

- The cap should be a substantial and legible element, distinct from the body of the building. Parapets are useful in providing a suitable scale for the cap.
- The cap should include elements, such as cornices, that produce a shadow line near the top of the street façade.
- Detailing such as decorative inserts, niches, machicolation, and string courses are encouraged.
- Finials that continue the division of bays at the base and body are encouraged.



The cornice forms a definitive element at the top of the façade. It may be very deep, as above, or a relatively shallow construction, with pattern as its prominent characteristic. Both examples are from Collingwood.



9.5.3.9 Mechanical and Utility Equipment

Mechanical equipment and related infrastructure should not be readily visible.

Guidelines

1. Rooftop mechanical equipment, transformer vaults, heat pumps and other forms of mechanical equipment should be considered in design of the building.
2. These elements should be designed or screened to reduce their visual impact on the subject building, the streetscape and neighbouring properties, as well as ensure that noise and servicing does not have an impact on neighbouring properties.

9.5.3.10 Loading, Garbage and Storage

Loading, garbage and storage areas should not be readily visible.

Guidelines

1. Loading, storage and other service areas should not be visible from any public street. Building form and placement should be designed to provide screening of these areas in order to reduce their visual impact.
2. Location and access to garbage receptacles and storage shall conform to the Zoning By-law.

9.5.3.11 Commercial Patios

Successful commercial patios can greatly contribute to the character of the street. Care should be taken, however, in their design to ensure that they complement and not detract from the street in terms of visual appearance and interaction with the surrounding environment.

Commercial patios which serve alcohol are by law required to be separated from the street. A key way of integrating the patio into the street is through the use of traditional landscape features such as a wood picket fence to serve as its boundary. Similarly, furniture, awnings, umbrellas, and landscape treatment should all be compatible with the character of the street and should comply with the spirit of the District Plan.

Guidelines:

1. Commercial patios are required to comply with the City of Vaughan Zoning By-law.
2. All patios should reflect and enhance the existing streetscape. Features such as wood picket fences and furniture that is compatible with the Heritage District is encouraged.
3. Commercial rooftop patios are not appropriate for the District.
4. Umbrellas which have advertising are not permitted.
5. Outdoor patios that include structural elements such as a raised roof or floor require permits under the *Building Code Act*.

9.6.1 Overview

Work within the road allowance should be designed and executed to meet modern requirements, amenity, and convenience, without detriment to the heritage character of the District. This work is either undertaken by public authorities, as in the case of roadside planting and the construction of roads, curbs, sidewalks, lighting, and road signage or it is subject to approval by public authorities, as in the case of BIA installations, newspaper boxes, and tourism information or identity signage.

District Identity

Installations within the road allowances have a significant effect on the experience of the heritage character of the District and the establishment of a sense of identity. The use of a consistent design vocabulary at the various scales and in the various kinds of road allowance work reinforces the District's identity and supports its economic role as a place of unique historical character in the community. Permits are required for the installation of items such as sidewalks, curbs, paving, street and pedestrian lighting, benches, tree grates, tree guards, trash receptacles, recycling bins, and parking equipment.

Contexts

Thornhill possesses two distinct contexts: the Residential Areas (including residential buildings converted to commercial use on Centre Street), and the Yonge Street Commercial Core. The goals of the Guidelines for streetscaping are:

- Enhancing historical character of the road allowances in the Residential Areas.
- Creation of a pedestrian-friendly shopping environment in the Commercial Core.
- Establishing identity through gateways, signage, and markers.

9.6.2 The Residential Streets



Except for Yonge and Centre Streets, the District streets have a curbless rural profile.



Roadways

Brooke Street, Elizabeth Street, Mill Street, Old Jane Street, and Old Yonge Street have a curbless rural profile. Other residential areas have grassed boulevards, to a great extent. These are an important part of the heritage character of these streets

Guidelines

- The rural profile should be preserved where it exists.
- Over time, grassed boulevards should be provided where they don't already exist.

Planting

Rural villages are planted informally, with a mix of trees and deciduous shrubs.

Guidelines

- Maintain a village character in street planting. The linear urban planting pattern of regularly spaced boulevard trees is not appropriate here.
- See Section 9.7 for suggested species.



9.6.3 Commercial Core

Overview

Creation of a pedestrian-friendly commercial environment is the most important objective of streetscape work in the Commercial Core. It is at the heart of the *Thornhill Yonge Street Study, 2005*.

Streetscape installations are an important aspect of meeting the objectives of conserving the heritage character, reducing the impact of traffic on the pedestrian environment, and creating a viable commercial destination.

Early 20th-century photographs of Thornhill show streetscapes very different from today's. An accurate "historical reproduction" would exclude automobiles, paving, lighting, highway signs, bollards, and benches. It's obvious that a lively commercial area requires all of these things, some of them because they enable and enhance public use and commercial activity in the village core, many of them because regulations and standards govern the design of traffic systems, lighting levels, and so on. There is an inherent historical ambiguity in a Heritage District that must be addressed when evaluating the design of these modern installations. The following principles apply to such an evaluation:

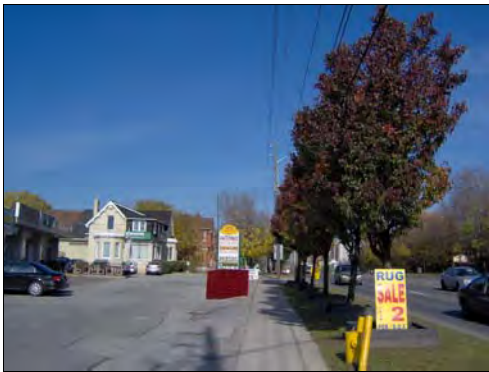

Creation of a pedestrian-friendly core faces many challenges.

9.6.3 Commercial Core Cont'd

Principles

1. Adapt to the automotive streetscape: As the list of modern artifacts above shows, the automobile and its associated infrastructure account for much of the visible non-heritage installations in the District. There is a built-in division of the streetscape in its historical aspect: it is inescapably modern from curb to curb. Modern accessories like waste receptacles and street lighting should be placed near to the curb, where they form a transition band between the heritage experience of the buildings and the modern experience of the roadway.

2. Don't accentuate non-heritage installations: Human perception is very good at filtering out unimportant and repetitive information. The modern enthusiasm for heritage has produced a host of "old-fashioned" products. Many of these are poorly executed and overly fussy. As a result, they call undeserved attention to themselves and the attention, thus directed, detects the fraud. Often, a very simple modern item will fade into the recesses of perception and be less intrusive than a deliberately "historical" version.

3. Maintain historical integrity: Even when they don't represent an accurate reconstruction, it is important to choose "historical" items in the context of history. For example, the streetlighting of 1890 can't be reconstructed because there was none. The designer should bear in mind that Thornhill was a modest village and ask, "If the village HAD installed early lighting, what sort of fixtures would have been chosen?" They would have been simple and functional, and would not have had the ornate qualities of lighting for a big-city promenade.

Applying artificial heritage elements to modern items only calls attention to the inauthenticity of the exercise. It's better to choose unobtrusive designs. In the example below, the bus shelter doesn't work, but the waste container does.



Lighting

A consistent street light design family should be used throughout the District to enhance its identity as a heritage area. The selected street light fixtures should reflect the village-like, heritage character of the District. Selection should be made in consultation with the Town of Markham, so that the design will enhance the unity of the two sides of the village. Selected fixtures should meet “dark skies” standards.

Street Furniture

Selection of street furniture should follow the principles outlined above. In general, items that might have appeared in a village environment should be selected for authenticity. Items that are modern interjections should be selected for unobtrusiveness. It is recommended that street furniture items be black, as it helps keep these items in the visual background, and is an historic colour for painted metal items like light posts and bench ends.

Benches should be the traditional flat-slat type with cast metal ends, in a simple design. Bench castings are available with cast-in or bolted-on lettering, which could serve as a District identity marker.

Waste and Recycling Bins should have a simple design, and should be constructed so that plastic garbage-bag liners are not visible. Box-type recycling bins bearing advertising are not appropriate.

Tree Guards should have a simple design, compatible with the design of waste and recycling bins.

Planters were not part of the historic streetscape but they have become established as “softeners” in business areas everywhere. In that sense, they resemble the non-functional “heritage” dormers, cupolas, and gazebos that flourish on modern shopping plazas. To the extent that planters are part of the modern commercial landscape, they should take a form that reflects the traditional garden pattern of rectangular beds. It is generally preferable to use in-ground planting, rather than planters. Hanging flower baskets should be minimized, since they were not part of the historic streetscape, and have become a symbol of urban shopping districts.

Utilities

Utility installations such as overhead wiring, telecommunication boxes and transformers detract from the heritage character of the District.

Guidelines:

- Utility installations such as switch boxes and transformers should be located so that they are not readily visible from the street and do not unduly impact the heritage qualities of the streetscape. Screening should be provided when they cannot be located away from the street frontage, where possible considering required clearances.
- Repairs to utilities do not require a heritage permit.
- Strong consideration should be given to the burial of utility wires in the District.

Gateways

Gateway markers at principal entrances to the District would serve to reinforce its identity and to promote the District as a place of unique historical character in the community and region. Markers should be placed so that they reinforce an existing sense of entrance, rather than at the exact point that a roadway crosses the District boundary.

Guidelines:

- Markers should be placed: At the principal entry points on Yonge and Centre Streets. Consultation with the Town of Markham on the design of the markers should be undertaken, in support of the unity of both sides of the village.

9.7.1 Planting

No heritage permits are required for planting activities, but voluntary compliance with the guidelines in this Section can help maintain and enhance the natural heritage of Thornhill and its valleys.

Suitable new planting and management of existing flora are a primary means of ensuring the health of the entire ecosystem: plants contribute to stormwater and groundwater management, erosion control, and provide habitat and nutrition for wild fauna.

Guidelines:

- Maintain health of mature indigenous tree by pruning and fertilizing, and by preventing intrusion that may damage the root systems.
- Over time, remove unhealthy, invasive and non-indigenous species.
- Site buildings and additions to preserve suitable mature trees.

Suitable indigenous species:

- Sugar Maple, Red Oak, Basswood, Silver Maple, Bitternut, Butternut, White Pine, Hemlock, American Elm, Red Maple, Bur Oak, White Spruce.

Suitable salt-tolerant species (for roadside planting):

- Little Leaf Linden, Serviceberry, Freeman Maple, Bur Oak, Red Oak, Kentucky Coffee Tree.

Unsuitable species:

- Manitoba Maple, Hawthorn, Black Locust, and Buckthorn tend to be invasive.
- Ornamental species, particularly Norway Maple cultivars, are extremely invasive.

9.7.2 Warning! Invasive Plant Species



Of the roughly 2600 identified vascular plant species that grow wild in Ontario, more than 25% are aliens or exotics not native to the province. These importations have been going on since Europeans first arrived, either as deliberate introductions or as stowaways in cargoes, ballasts, and debris. However and whenever they arrived, these species have found hospitable ecological niches. Once established they make use of the plant world's full array of propagation strategies. Without the pests and competitors of their native environments, many are able to out-compete native species, and may seriously threaten entire native ecosystems, replacing a host of native plants that together provided food and habitat for native wildlife. The Federation of Ontario Naturalists has more detailed information on invasive species and their control on their website.

Guidelines:

Although planting is not regulated by this Plan, it is environmentally prudent to avoid these invasive plant species:

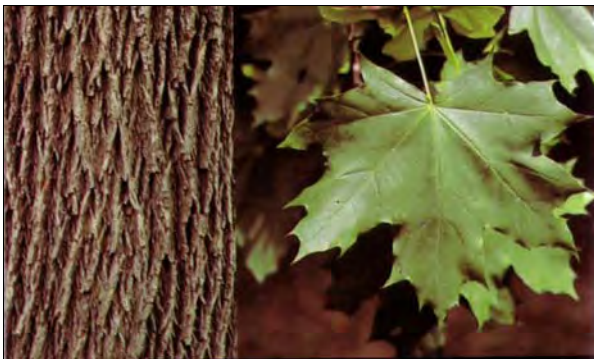

Two prime invaders are Purple Loosestrife, above, and Norway Maple, below. Both have been popular for garden and street planting, and both have proven to be highly invasive. Images from Audubon Society Field Guides.

- Purple Loosestrife
- Norway Maple
- European Birch
- Highbush Cranberry
- European Mountain Ash
- Privet
- White Mulberry
- Horse Chestnut
- Scots Pine
- Crown Vetch
- Periwinkle
- Dame's Rocket
- Winter Cress
- Silver Poplar
- Siberian Elm
- Himalayan Balsam
- Russian Olive
- Sweet Woodruff

9.8 Building Materials Checklist

All construction visible from the exterior requires a Heritage Permit. Visible materials should conform to the following standards:

9.8.1 Heritage Buildings

Appropriate Materials:

Exterior Finish:	Smooth red clay face brick, with smooth buff clay face brick as accent. Wood clapboard, 4" to the weather. Smooth, painted, wood board and batten siding.
Exterior Detail:	Cut stone or reconstituted stone for trim in brick buildings. Wood shingles, stucco, or terra-cotta wall tiles in gable ends. Painted wood porches, railings, decorative trim, shutters, fascias and soffits. Painted wood gingerbread bargeboards and trim, where appropriate to the design.
Shopfronts:	Wood frames, glazing bars, and panels with glazed wood doors are preferred. Metal shopfronts, detailed and proportioned to be compatible with heritage shopfronts, are acceptable.
Roofs:	Hipped or gable roof as appropriate to the architectural style. Cedar, slate, simulated slate, or asphalt shingles of an appropriate colour. Standing seam metal roofing, if appropriate to the style. Skylights in the form of cupolas or monitors are acceptable, if appropriate to the style.
Doors:	Wood doors and frames, panel construction, may be glazed. Transom windows and paired sidelights. Wood french doors for porch entrances. Single-bay wood panelled garage doors.
Windows:	Wood frames; double hung; lights as appropriate to the architectural style. Real glazing bars, or high-quality simulated glazing bars. Vertical proportion, ranging from 3:5 to 3:7.
Flashings:	Visible step flashings should be painted the colour of the wall.

9.8.1 Heritage Buildings

Inappropriate Materials

Exterior Finish:	Concrete block; calcite or concrete brick. Textured, clinker, or wire cut brick. Precast concrete panels or cast-in-place concrete. Prefabricated metal or plastic siding. Stone or ceramic tile facing. “Rustic” clapboard or “rustic” board and batten siding; wood shake siding.
Exterior Detail:	Prefinished metal fascias and soffits. “Stock” suburban pre-manufactured shutters, railings, and trims. Unfinished pressure-treated wood decks, porches, railings, and trim.
Shopfronts:	Standard metal shopfronts and pre-finished metal spandrel material. Frameless tempered glass shopfronts.
Roofs:	Slopes or layouts not suitable to the architectural style. Non-traditional metal roofing such as pre-finished or corrugated metal. Modern skylights, when facing the street.
Doors:	“Stock” suburban door assemblies. Flush doors. Sidelights on one side only. Aluminum storm and screen doors. Sliding patio doors. Double-bay, slab, or metal garage doors.

9.8.1 Heritage Buildings

Inappropriate Materials

- Windows: Large “picture” windows.
 Curtain wall systems.
 Metal, plastic, or fibreglass frames.
 Metal or plastic cladding.
 Awning, hopper, or sliding openers.
 “Snap-in” or tape simulated glazing bars.
- Flashings: Pre-finished metal in inappropriate colours.

9.8.2 Non-Heritage Buildings

Note: If using the Historical Conversion approach, described in Section 9.4.1.1, follow the Heritage Building Checklist, above.

Appropriate Materials

- Exterior Finish: Use materials compatible with the original design.
- Roofs: Slopes and layouts compatible with the original design.
- Doors: Use materials and designs compatible with the original design.
- Windows: Use windows compatible with the original design.